

ASUS[®]

T3-P5G965

ASUS PC (Desktop Barebone)

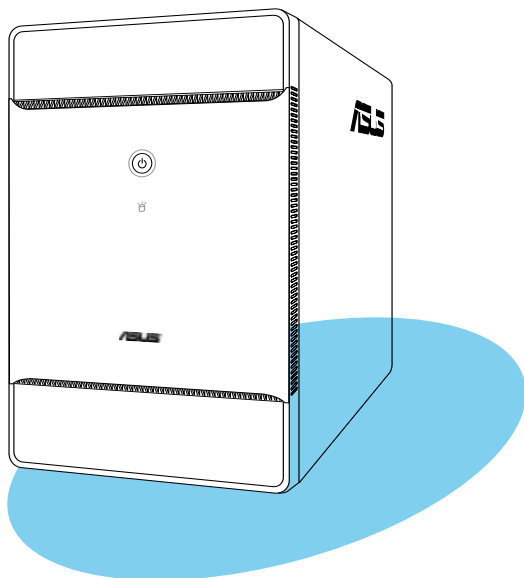

E3290

June 2007

Copyright © 2007 ASUSTeK COMPUTER INC. All Rights Reserved.

No part of this manual, including the products and software described in it, may be reproduced, transmitted, transcribed, stored in a retrieval system, or translated into any language in any form or by any means, except documentation kept by the purchaser for backup purposes, without the express written permission of ASUSTeK COMPUTER INC. ("ASUS").

Product warranty or service will not be extended if: (1) the product is repaired, modified or altered, unless such repair, modification or alteration is authorized in writing by ASUS; or (2) the serial number of the product is defaced or missing.

ASUS PROVIDES THIS MANUAL "AS IS" WITHOUT WARRANTY OF ANY KIND, EITHER EXPRESS OR IMPLIED, INCLUDING BUT NOT LIMITED TO THE IMPLIED WARRANTIES OR CONDITIONS OF MERCHANTABILITY OR FITNESS FOR A PARTICULAR PURPOSE. IN NO EVENT SHALL ASUS, ITS DIRECTORS, OFFICERS, EMPLOYEES OR AGENTS BE LIABLE FOR ANY INDIRECT, SPECIAL, INCIDENTAL, OR CONSEQUENTIAL DAMAGES (INCLUDING DAMAGES FOR LOSS OF PROFITS, LOSS OF BUSINESS, LOSS OF USE OR DATA, INTERRUPTION OF BUSINESS AND THE LIKE), EVEN IF ASUS HAS BEEN ADVISED OF THE POSSIBILITY OF SUCH DAMAGES ARISING FROM ANY DEFECT OR ERROR IN THIS MANUAL OR PRODUCT.

SPECIFICATIONS AND INFORMATION CONTAINED IN THIS MANUAL ARE FURNISHED FOR INFORMATIONAL USE ONLY, AND ARE SUBJECT TO CHANGE AT ANY TIME WITHOUT NOTICE, AND SHOULD NOT BE CONSTRUED AS A COMMITMENT BY ASUS. ASUS ASSUMES NO RESPONSIBILITY OR LIABILITY FOR ANY ERRORS OR INACCURACIES THAT MAY APPEAR IN THIS MANUAL, INCLUDING THE PRODUCTS AND SOFTWARE DESCRIBED IN IT.

Products and corporate names appearing in this manual may or may not be registered trademarks or copyrights of their respective companies, and are used only for identification or explanation and to the owners' benefit, without intent to infringe.

Table of contents

Notices	vi
Safety information	vii
About this guide.....	viii
System package contents.....	x

Chapter 1: System introduction

1.1	Welcome!	1-2
1.2	Front panel (external).....	1-2
1.3	Front panel (internal).....	1-3
1.4	Rear panel.....	1-4
1.5	Internal components.....	1-6

Chapter 2: Basic installation

2.1	Preparation	2-2
2.2	Before you proceed	2-2
2.3	Removing the cover.....	2-3
2.4	Removing the power supply unit	2-4
2.5	CPU installation.....	2-5
2.5.1	Installing the CPU.....	2-5
2.5.2	Reinstalling the CPU fan and heatsink assembly	2-7
2.6	Installing a DIMM	2-8
2.6.1	Memory configurations	2-8
2.6.2	DIMM installation	2-12
2.7	Installing an expansion card.....	2-13
2.7.1	Expansion slots	2-13
2.7.2	Expansion card installation.....	2-14
2.8	Installing an optical drive	2-15
2.9	Installing a Serial ATA disk drive.....	2-16
2.10	Reinstalling the power supply unit.....	2-17
2.11	Replacing the cover	2-18

Chapter 3: Starting up

3.1	Installing an operating system.....	3-2
3.2	Powering up	3-2
3.3	Support CD information.....	3-2
3.3.1	Running the support CD.....	3-3

Table of contents

3.3.2	Drivers menu	3-3
3.3.3	Utilities menu	3-4
3.3.4	ASUS contact information	3-6
3.3.5	Other information	3-6

Chapter 4: Motherboard info

4.1	Introduction	4-2
4.2	Motherboard layout	4-2
4.3	Jumpers	4-3
4.4	Connectors	4-5

Chapter 5: BIOS setup

5.1	Managing and updating your BIOS	5-2
5.1.1	ASUS EZ Flash 2 utility.....	5-3
5.1.2	AFUDOS utility	5-4
5.1.3	ASUS CrashFree BIOS 2 utility	5-6
5.1.4	ASUS Update utility	5-8
5.2	BIOS setup program.....	5-11
5.2.1	BIOS menu screen	5-12
5.2.2	Menu bar	5-12
5.2.3	Navigation keys.....	5-12
5.2.4	Menu items	5-13
5.2.5	Sub-menu items.....	5-13
5.2.6	Configuration fields	5-13
5.2.7	Pop-up window.....	5-13
5.2.8	Scroll bar	5-13
5.2.9	General help	5-13
5.3	Main menu.....	5-14
5.3.1	System Time	5-14
5.3.2	System Date	5-14
5.3.3	SATA1, SATA2, and SATA3	5-15
5.3.4	IDE Configuration	5-16
5.3.5	System Information.....	5-17
5.4	Advanced menu	5-17
5.4.1	USB Configuration.....	5-18

Table of contents

5.4.2	CPU Configuration	5-19
5.4.3	Chipset.....	5-20
5.4.4	Onboard Devices Configuration.....	5-22
5.4.5	PCI PnP.....	5-23
5.5	Power menu	5-25
5.5.1	Suspend Mode	5-25
5.5.2	Repost Video on S3 Resume	5-25
5.5.3	ACPI 2.0 Support	5-25
5.5.4	ACPI APIC Support	5-25
5.5.5	APM Configuration	5-26
5.5.6	Hardware Monitor.....	5-27
5.6	Boot menu	5-28
5.6.1	Boot Device Priority	5-28
5.6.2	Boot Settings Configuration	5-29
5.6.3	Security.....	5-30
5.7	Tools menu	5-32
5.7.1	ASUS EZ Flash 2.....	5-32
5.7.2	ASUS O.C. Profile	5-33
5.8	Exit menu.....	5-34

Appendix

Power supply specifications	A-2
-----------------------------------	-----

Notices

Federal Communications Commission Statement

This device complies with Part 15 of the FCC Rules. Operation is subject to the following two conditions:

- This device may not cause harmful interference, and
- This device must accept any interference received including interference that may cause undesired operation.

This equipment has been tested and found to comply with the limits for a Class B digital device, pursuant to Part 15 of the FCC Rules. These limits are designed to provide reasonable protection against harmful interference in a residential installation. This equipment generates, uses and can radiate radio frequency energy and, if not installed and used in accordance with manufacturer's instructions, may cause harmful interference to radio communications. However, there is no guarantee that interference will not occur in a particular installation. If this equipment does cause harmful interference to radio or television reception, which can be determined by turning the equipment off and on, the user is encouraged to try to correct the interference by one or more of the following measures:

- Reorient or relocate the receiving antenna.
- Increase the separation between the equipment and receiver.
- Connect the equipment to an outlet on a circuit different from that to which the receiver is connected.
- Consult the dealer or an experienced radio/TV technician for help.



WARNING! The use of shielded cables for connection of the monitor to the graphics card is required to assure compliance with FCC regulations. Changes or modifications to this unit not expressly approved by the party responsible for compliance could void the user's authority to operate this equipment.

Canadian Department of Communications Statement

This digital apparatus does not exceed the Class B limits for radio noise emissions from digital apparatus set out in the Radio Interference Regulations of the Canadian Department of Communications.

This class B digital apparatus complies with Canadian ICES-003.

Safety information

Electrical safety

- To prevent electrical shock hazard, disconnect the power cable from the electrical outlet before relocating the system.
- When adding or removing devices to or from the system, ensure that the power cables for the devices are unplugged before the signal cables are connected.
- If the power supply is broken, do not try to fix it by yourself. Contact a qualified service technician or your retailer.

Operation safety

- Before installing devices into the system, carefully read all the documentation that came with the package.
- Before using the product, make sure all cables are correctly connected and the power cables are not damaged. If you detect any damage, contact your dealer immediately.
- To avoid short circuits, keep paper clips, screws, and staples away from connectors, slots, sockets and circuitry.
- Avoid dust, humidity, and temperature extremes. Do not place the product in any area where it may become wet. Place the product on a stable surface.
- If you encounter technical problems with the product, contact a qualified service technician or your retailer.

Lithium-Ion Battery Warning

CAUTION: Danger of explosion if battery is incorrectly replaced. Replace only with the same or equivalent type recommended by the manufacturer. Dispose of used batteries according to the manufacturer's instructions.

VORSICHT: Explosionsgefahr bei unsachgemäßen Austausch der Batterie. Ersatz nur durch denselben oder einem vom Hersteller empfohlenem ähnlichen Typ. Entsorgung gebrauchter Batterien nach Angaben des Herstellers.

LASER PRODUCT WARNING

CLASS 1 LASER PRODUCT

About this guide

Audience

This guide provides general information and installation instructions about the ASUS T3-P5G965 barebone system. This guide is intended for experienced users and integrators with hardware knowledge of personal computers.

How this guide is organized

This guide contains the following parts:

1. Chapter 1: System introduction

This chapter gives a general description of the ASUS T2-PH1. The chapter lists the system features, including introduction on the front and rear panel, and internal components.

2. Chapter 2: Basic installation

This chapter provides step-by-step instructions on how to install components in the system.

3. Chapter 3: Starting up

This chapter helps you power up the system and install drivers and utilities from the support CD.

4. Chapter 4: Motherboard information

This chapter gives information about the motherboard that comes with the system. This chapter includes the motherboard layout, jumper settings, and connector locations.

5. Chapter 5: BIOS information

This chapter tells how to change system settings through the BIOS Setup menus and describes the BIOS parameters.

6. Appendix

The Appendix includes the power supply unit specification for this system.

Conventions used in this guide



WARNING: Information to prevent injury to yourself when trying to complete a task.



CAUTION: Information to prevent damage to the components when trying to complete a task.



IMPORTANT: Instructions that you **MUST** follow to complete a task.



NOTE: Tips and additional information to aid in completing a task.

Where to find more information

Refer to the following sources for additional information and for product and software updates.

1. **ASUS Websites**

The ASUS websites worldwide provide updated information on ASUS hardware and software products. Refer to the ASUS contact information.

2. **Optional Documentation**

Your product package may include optional documentation, such as warranty flyers, that may have been added by your dealer. These documents are not part of the standard package.

System package contents

Check your T3-P5G965 system package for the following items.



If any of the items is damaged or missing, contact your retailer immediately.

Item description
1. ASUS T3-P5G965 barebone system with
• ASUS motherboard
• 250 W PFC power supply unit
• Gigabit LAN port
• CPU fan and heatsink assembly
• 1 x 5.25" drive bays
• 2 x 3.5" hard disk drive bay
• 6 x USB 2.0 ports
• 2 x IEEE 1394a ports
• S/PDIF IN&OUT port
• 7-in-1 storage card reader
2. Cables
• AC power cord
• ATA cable
• Serial ATA cable
• Serial ATA power cable
3. Support CD
4. User guide
5. Optional items
• Optical drive (CD-ROM/CD-RW/DVD-ROM/DVD-RW)

Chapter 1

This chapter gives a general description of the ASUS T3-P5G965. The chapter lists the system features including introduction on the front and rear panel, and internal components.

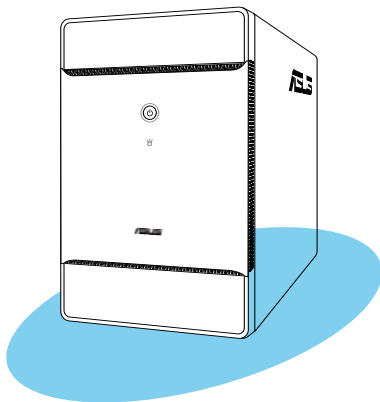

System introduction

1.1 Welcome!

Thank you for choosing the ASUS T3-P5G965!

The ASUS T3-P5G965 is an all-in-one barebone system with a versatile home entertainment feature.

The system comes in a stylish mini-tower casing, and powered by the ASUS motherboard that supports the Intel® Pentium® 4 processor in the 775-land package with 533/800/1066 MHz FSB and up to 2 GB system memory.



With audio functions, extensive connectivity, and Gigabit LAN capability, the T3-P5G965 is designed for the sophisticated.

With these and many more, the T3-P5G965 definitely delivers the cutting edge technology for your computing and multimedia needs!

1.2 Front panel (external)

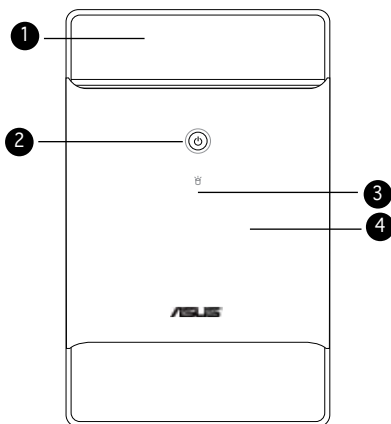
The front panel includes the system and audio control buttons, system LEDs, and LED panel.







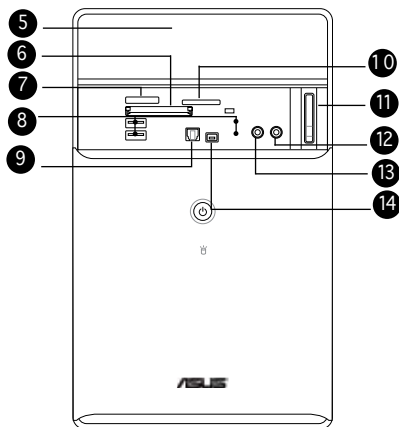

1. **Drive door.** Open this door to access the disk drive.
2. **Power button** . Press this button to turn the system on.
3. **HDD LED** . This LED lights up when data is being read from or written to the hard disk drive.
4. **Front panel I/O door.** Push down this door to show the input/output ports.

1.3 Front panel (internal)

The optical drive(s), storage card reader slots, and several I/O ports are located inside the front panel doors.

Open the front panel door by pushing it downwards.









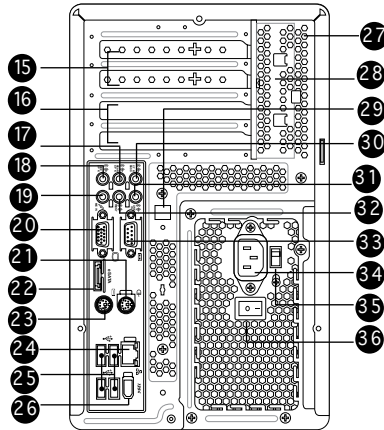



5. **Optical Drive** (*optional*). This is for the optical disks.
6. **CompactFlash®/Microdrive™ card slot** . This slot is for a CompactFlash®/Microdrive™ storage card.
7. **Memory Stick®/Memory Stick Pro™ card slot**. This slot is for a Memory Stick®/Memory Stick Pro™ storage card.
8. **USB 2.0 ports** . These Universal Serial Bus 2.0 (USB 2.0) ports are available for connecting USB 2.0 devices such as a mouse, printer, scanner, camera, PDA, and others.
9. **S/PDIF In port**. This port connects your audio system for 5.1-channel surround sound and enhanced 3D audio.
10. **Secure Digital™/MultimediaCard slot** . This slot is for a Secure Digital™/MultimediaCard storage card.
11. **Eject button**. Press this button to eject the optical drive bay.
12. **Microphone port** . This Mic (pink) port connects a microphone.
13. **Headphone port** . This port connects a headphone with a stereo mini-plug.
14. **4-pin IEEE 1394a port** . This port provides high-speed connectivity for IEEE 1394a-compliant audio/video devices, storage peripherals, and other PC devices.

1.4 Rear panel

The system rear panel includes the power connector and several I/O ports that allow convenient connection of devices.



15. **Expansion slot covers.** Remove these covers when installing expansion cards.
16. **Expansion slots.** Use these slots when installing expansion cards.
17. **Rear surround speakers.** This port connects to a high-definition six-channel speaker.
18. **Side surround speakers.** This port connects to a high-definition six-channel speaker.
19. **Microphone port** . This Microphone (pink) port connects a microphone. In 4/6-channel mode, the function of this port becomes Low Frequency Enhanced Output/Center.
20. **VGA port** . This port connects a VGA monitor.
21. **PS/2 mouse port** . This green 6-pin connector is for a PS/2 mouse.
22. **External SATA port.** This port connects to a SATA hard disk drive.
23. **PS/2 keyboard port** . This purple 6-pin connector is for a PS/2 keyboard.
24. **LAN (RJ-45) port** . This port allows Gigabit connection to a Local Area Network (LAN) through a network hub.
25. **USB 2.0 ports**  **2.0**. These Universal Serial Bus 2.0 (USB 2.0) ports are available for connecting USB 2.0 devices such as a mouse, printer, scanner, camera, PDA, and others.

26. **6-pin IEEE 1394a port **. This port provides high-speed connectivity for IEEE 1394a-compliant audio/video devices, storage peripherals, and other PC devices.
27. **Chassis vent.** This vent is for the fan that provides ventilation inside the system chassis.
28. **Expansion card lock.** This lock secures installed expansion cards. See page 2-15 for details.
29. **S/PDIF Out port.** This port connects your audio system for 5.1-channel surround sound and enhanced 3D audio.
30. **Center & woofer speakers.**
31. **Line In port **. This Line In (light blue) port connects a tape player or other audio sources. In 6-channel mode, the function of this port becomes Surround output.
32. **Line Out port **. This Line Out (lime) port connects a headphone or a speaker. In 4/6-channel mode, the function of this port becomes Front Speaker Out.
33. **COM port **. This port connects a mouse, modem, or other devices that conforms with serial specification.
34. **Power connector.** This connector is for a power cable and plug.
35. **Voltage selector.** This switch allows you to adjust the system input voltage according to the voltage supply in your area.
36. **Power switch.** This switch allows you to turn your PC on/off..

1.5 Internal components

The illustration below is the internal view of the system when you remove the top cover and the power supply unit. The installed components are labeled for your reference. Proceed to Chapter 2 for instructions on installing additional system components.



The illustration shows an open chassis lifted at a 90° angle.

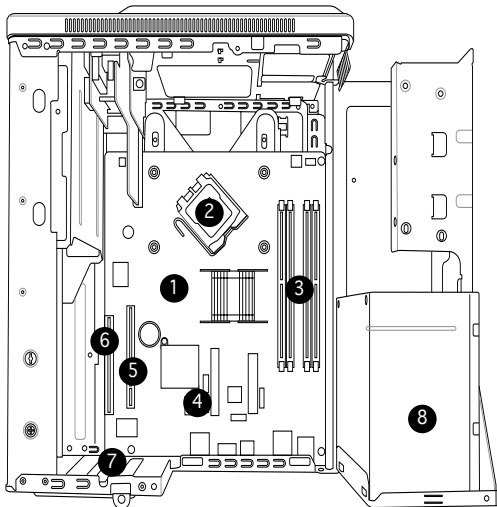

1. ASUS motherboard
2. LGA775 socket with PnP cap
3. DIMM sockets
4. Serial ATA connectors
5. PCI Express™ x16 slot for discrete graphics card
6. PCI slot
7. Expansion card slots
8. Power supply unit

Chapter 2

This chapter provides step-by-step instructions on how to install components in the system.

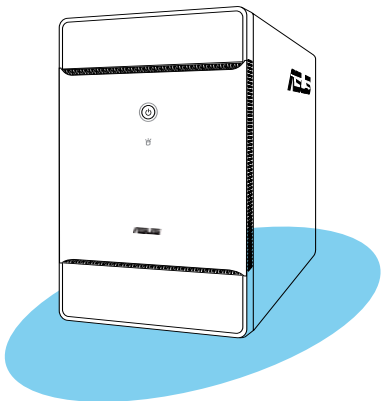

Basic installation

2.1 Preparation

Before you proceed, make sure that you have all the components you plan to install in the system.

Basic components to install

1. Central Processing Unit (CPU)
2. DDR2 Dual Inline Memory Module (DIMM)
3. Expansion card(s)
4. Hard disk drive
5. Optical drive

Tool

Philips (cross) screw driver

2.2 Before you proceed

Take note of the following precautions before you install components into the system.



- Use a grounded wrist strap or touch a safely grounded object or a metal object, such as the power supply case, before handling components to avoid damaging them due to static electricity.
- Hold components by the edges to avoid touching the ICs on them.
- Whenever you uninstall any component, place it on a grounded antistatic pad or in the bag that came with the component.

The motherboard comes with an onboard standby power LED. This LED lights up to indicate that the system is ON, in sleep mode or in soft-off mode, and not powered OFF. Unplug the power cable from the power outlet and make sure that the standby power LED is OFF before installing any system component.

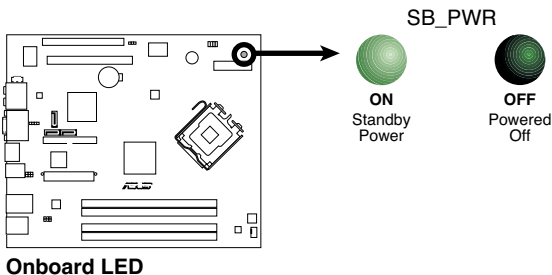

2.3 Removing the cover

To remove the cover:

1. On the rear panel, locate the three screws that secure the cover to the chassis.

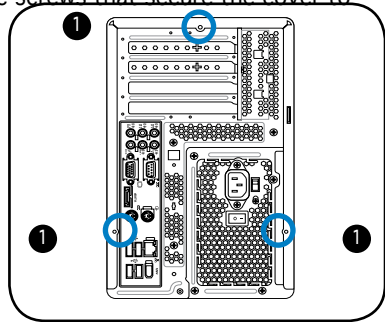

2. Use a Phillips screw driver to remove the cover screws. Keep the screws for later use.

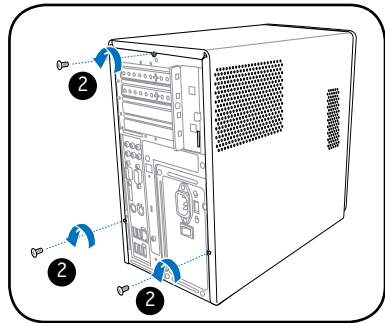

3. Slightly pull the cover toward the rear panel until the side tabs are disengaged from the chassis.
4. Lift the cover, then set aside.

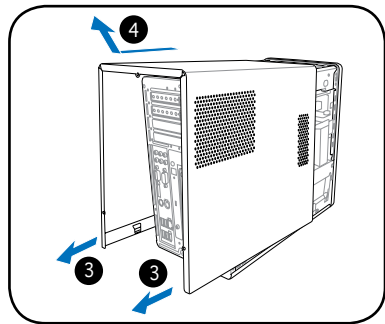

2.4 Removing the power supply unit

You need to remove the power supply unit (PSU) before you can install a central processing unit (CPU) and other system components.

To remove the PSU:

1. Lay the system chassis on its side on a flat and stable surface.
2. Disconnect the optical drive power connector.
3. Locate and remove the two screws that secures the PSU to the chassis.
4. Lift the PSU in the direction of the arrow to a 90° angle.

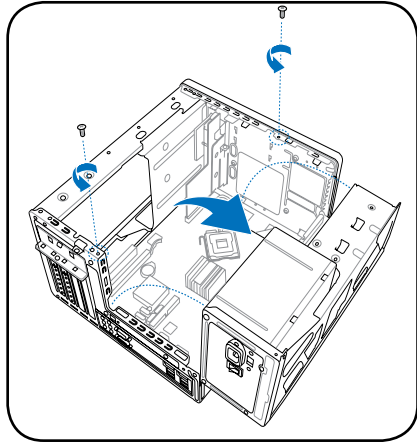

When removing the PSU, make sure to hold or support it firmly. The unit may accidentally drop and damage other system components.

2.5 CPU installation



- Your boxed Intel® Pentium® 4 LGA775 processor package should come with installation instructions for the CPU, heatsink, and the retention mechanism. If the instructions in this section do not match the CPU documentation, follow the latter.
- Check your motherboard to make sure that the PnP cap is on the CPU socket and the socket contacts are not bent. Contact your retailer immediately if the PnP cap is missing, or if you see any damage to the PnP cap/socket contacts/motherboard components. ASUS will shoulder the cost of repair only if the damage is shipment/transit-related.
- Keep the cap after installing the motherboard. ASUS will process Return Merchandise Authorization (RMA) requests only if the motherboard comes with the cap on the LGA775 socket.
- The product warranty does not cover damage to the socket contacts resulting from incorrect CPU installation/removal, or misplacement/loss/incorrect removal of the PnP cap.

2.5.1 Installing the CPU



IMPORTANT! Before installing the CPU, remove the two rubbers (A and B) attached to the bottom of the cooler / fan.

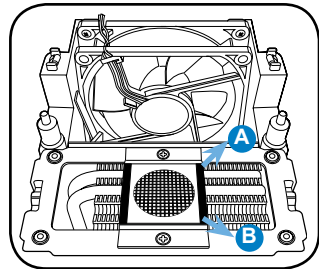

To install a CPU:

1. Locate the CPU socket on the motherboard.

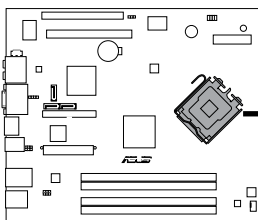

CPU Socket 775

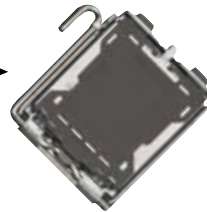

Before installing the CPU, make sure that the socket box is facing towards you and the load lever is on your left.

2. Press the load lever with your thumb (A), then move it to the left (B) until it is released from the retention tab.



To prevent damage to the socket pins, do not remove the PnP cap unless you are installing a CPU.

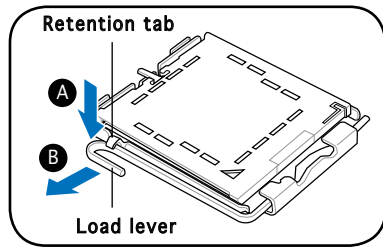

3. Lift the load lever in the direction of the arrow to a 135° angle.
4. Lift the load plate with your thumb and forefinger to a 100° angle (4A), then push the PnP cap from the load plate window to remove (4B).

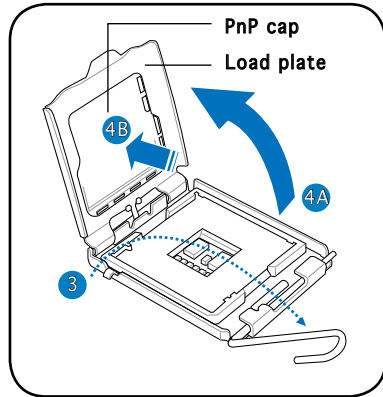

5. Position the CPU over the socket, making sure that the gold triangle is on the bottom-left corner of the socket then fit the socket alignment key into the CPU notch.

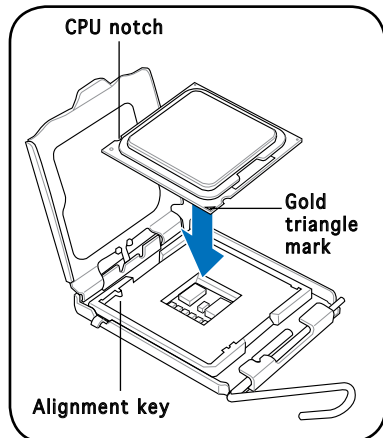

6. Close the load plate (A), then push the load lever (B) until it snaps into the retention tab.

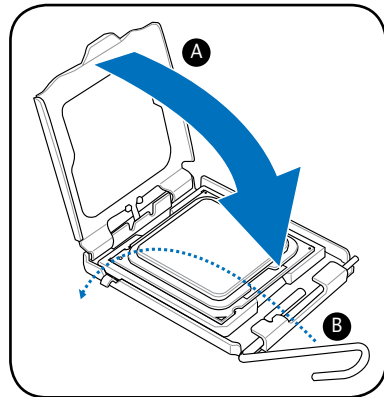

2.5.2 Reinstalling the CPU fan and heatsink assembly

To reinstall the CPU fan and heatsink assembly:

1. Position the CPU fan and heatsink assembly on top of the installed CPU.
2. Drive in the four screws you removed earlier into the CPU fan screw holes to secure the fan and heatsink assembly to the motherboard.
3. Connect the CPU fan cable to the CPU fan connector on the motherboard.

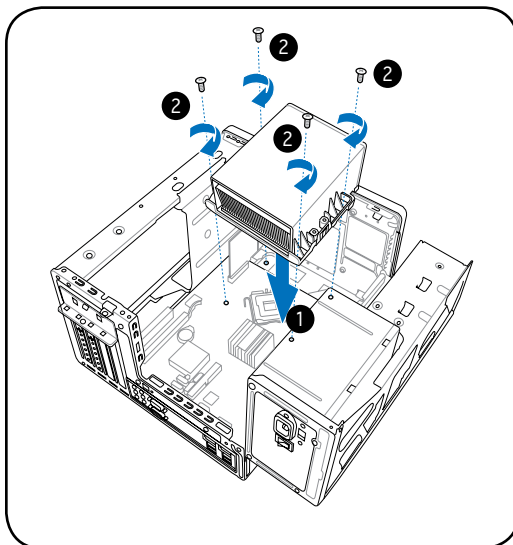

2.6 Installing a DIMM

The system motherboard comes with two Double Data Rate 2 (DDR2) Dual Inline Memory Module (DIMM) sockets.

The following figure illustrates the location of the sockets:

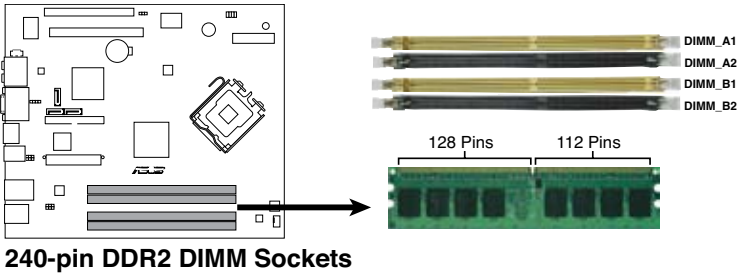

2.6.1 Memory configurations

You may install up to 4 GB system memory using 256 MB, 512 MB, and 1 GB DDR2 DIMMs.



- Installing DDR2 DIMMS other than the recommended configurations may cause memory sizing error or system boot failure. Use any of the recommended configurations in the table on the next page.
- Install only **identical** (the same type and size) DDR2 DIMMs in DIMM_A1 and DIMM_B1.
- Always install DIMMs with the same CAS latency. For optimum compatibility, we recommend that you obtain memory modules from the same vendor.
- Due to chipset resource allocation, the system may detect less than 2 GB system memory when you installed two 1 GB DDR2 memory.
- If installing only one DDR2 DIMM, please install it in DIMM_A1 or A2 first.
- This motherboard does not support memory modules made up of 128 Mb chips or double-sided x16 memory modules.

Recommended memory configurations

Mode	Sockets			
	DIMM_A1	DIMM_A2	DIMM_B1	DIMM_B2
Single Channel	Populated	-	-	-
	-	Populated	-	-
	-	-	-	-
	-	-	-	-
Dual-channel (1)	Populated	-	Populated	-
	-	Populated	-	Populated
Dual-channel (2)	Populated	Populated	Populated	Populated

DDR2 (667 MHz) Qualified Vendors List

Size	Vendor	Model	SS/DS	Component	DIMM support		
					A	B	C
512MB	KINGSTON	E5108AE-6E-E	SS	KVR667D2N5/512	v	v	v
1024MB	KINGSTON	E5108AE-6E-E	DS	KVR667D2N5/1G	v	v	v
512MB	KINGSTON	E5108AE-6E-E	SS	KVR667D2E5/512	v	v	v
256MB	KINGSTON	HYB18T256800AF3	SS	KVR667D2N5/256	v	v	v
512MB	KINGSTON	D6408TEBGG3U	SS	KVR667D2N5/512	v	v	v
1024MB	KINGSTON	D6408TEBGG3U	DS	KVR667D2N5/1G	v	v	v
256MB	KINGSTON	HYB18T256800AF3S	SS	KVR667D2N5/256	v	v	v
256MB	Qimonda	HYB18T512160AF-3S	SS	HYS64T32000HU-3S-A	v	v	v
512MB	Qimonda	HYB18T512800AF3S	SS	HYS64T64000HU-3S-A	v	v	v
1024MB	Qimonda	HYB18T512800AF3S	DS	HYS64T128020HU-3S-A	v	v	v
256MB	Qimonda	HYB18T256800AF3S(ECC)	SS	HYS72T32000HU-3S-A	v	v	v
512MB	Qimonda	HYB18T512800AF3S(ECC)	SS	HYS72T64000HU-3S-A	v	v	v
1024MB	Qimonda	HYB18T512800AF3S(ECC)	DS	HYS72T128020HU-3S-A	v	v	v
512MB	Qimonda	HYB18T512800BF3S(ECC)	SS	HYS72T64000HU-3S-B	v	v	v
1024MB	Qimonda	HYB18T512800BF3S(ECC)	DS	HYS72T128020HU-3S-B	v	v	v
256MB	Qimonda	HYB18T512160BF-3S	SS	HYS64T32000HU-3S-B	v	v	v
512MB	Qimonda	HYB18T512800BF3S	SS	HYS64T64000HU-3S-B	v	v	v
1024MB	Qimonda	HYB18T512800BF3S	DS	HYS64T128020HU-3S-B	v	v	v
256MB	SAMSUNG	K4T51163QC-ZCE6	SS	M378T3354C20-CE6	v	v	v
512MB	SAMSUNG	ZCE6K4T51083QC	SS	M378T6553C20-CE6	v	v	v
1024MB	SAMSUNG	ZCE6K4T51083QC	DS	M378T2953C20-CE6	v	v	v
1024MB	SAMSUNG	ZCE6K4T51083QC	DS	M378T2953C23-CE6	v	v	v
512MB	Hynix	HY5PS12821AFP-Y5	SS	HYMP564U64AP8-Y5	v	v	v
1024MB	Hynix	HY5PS12821AFP-Y5	DS	HYMP512U64AP8-Y5	v	v	v
1024MB	Hynix	HY5PS1G831FP-Y5(ECC)	SS	HYMP112U72P8-Y5	v	v	v
512MB	Hynix	HY5PS12821AFP-Y5(ECC)	SS	HYMP564U72AP8-Y5	v	v	v
1024MB	Hynix	HY5PS12821AFP-Y5(ECC)	DS	HYMP512U72AP8-Y5	v	v	v
512MB	Hynix	HY5PS12821AFP-Y4	SS	HYMP564U64AP8-Y4	v	v	v
1024MB	Hynix	HY5PS12821AFP-Y4	DS	HYMP512U64AP8-Y4	v	v	v
512MB	Hynix	HY5PS12821AFP-Y4(ECC)	SS	HYMP564U72AP8-Y4	v	v	v
1024MB	Hynix	HY5PS12821AFP-Y4(ECC)	DS	HYMP512U72AP8-Y4	v	v	v
256MB	CORSAIR	MIII00605	SS	VS256MB667D2	v	v	v
512MB	CORSAIR	64M8CFEG	SS	VS512MB667D2	v	v	v
1024MB	CORSAIR	64M8CFEG	DS	VS1GB667D2	v	v	v
256MB	ELPIDA	E2508AB-6E-E	SS	EBE25UC8ABFA-6E-E	v	v	v
512MB	ELPIDA	E5108AE-6E-E	SS	EBE51UD8AEFA-6E-E	v	v	v
512MB	A-DATA	AD29608A8B-3EG	SS	M20AD5Q3H3163J1C52	v	v	v
512MB	A-DATA	AD29608A8A-3EG	SS	M20AD5G3H316611C52	v	v	v
1024MB	A-DATA	AD29608A8A-3EG	DS	M20AD5G3I4176I1C52	v	v	v
512MB	crucial	Heat-Sink Package	SS	BL6464AA663.8FD	v	v	v
1024MB	crucial	Heat-Sink Package	DS	BL12864AA663.16FD	v	v	v
1024MB	crucial	Heat-Sink Package	DS	BL12864AL664.16FD	v	v	v

Size	Vendor	Model	SS/DS	Component	DIMM support		
					A	B	C
1024MB	Apacer	E5108AE-6E-E	DS	78.01092.420	v	v	v
512MB	Apacer	AM4B5708GQJS7E	SS	AU512E667C5KBGC	v	v	v
1024MB	Apacer	AM4B5708GQJS7E	DS	AU01GE667C5KBGC	v	v	v
512MB	Apacer	AM4B5708PJS7E	SS	AU512E667C5KBGC	v	v	v
512MB	Apacer	AM4B5708GQJS7E	SS	AU512E667C5KBGC	v	v	v
1024MB	Apacer	N/A	DS	AU01GE667C5KBGC	v	v	v
512MB	Kingmax	KKEA88B4LAUG-29DX	SS	KLCC28F-A8KB5	v	v	v
1024MB	Kingmax	KKEA88B4LAUG-29DX	DS	KLCD48F-A8KB5	v	v	v
512MB	Transcend	E5108AE-6E-E	SS	TS64MLQ64V6J	v	v	v
1024MB	Transcend	E5108AE-6E-E	DS	TS128MLQ64V6J	v	v	v
512MB	Transcend	J12Q3AB-6	SS	JM367Q643A-6	v	v	v
1024MB	Transcend	J12Q3AB-6	DS	JM388Q643A-6	v	v	v
512MB	Veritech	VTD264M8PC5G	SS	GTP512HLT45EG	v	v	v
1024MB	Veritech	VTD264M8PC5G	DS	GTP01GHLT55EG	v	v	v
512MB	TwinMOS	E5108AE-GE-E	SS	8G-25JK5-EBT	v	v	v
512MB	TwinMOS	TMM6208G8M30C	SS	8D-23JK5M2ETP	v	v	v
2048MB	NANYA	NT5TU128M8BJ-3C	DS	NT2GT64U8HB0JY-3C	v	v	v
1024MB	NANYA	NT5TU128M8BJ-3C	SS	NT1GT64U88B0JY-3C	v	v	v
512MB	GEIL	Heat-Sink Package	SS	GX21GB5300DC	v	v	v
512MB	GEIL	Heat-Sink Package	SS	GX21GB5300SDC	v	v	v
512MB	Aeneon	AET93F30DA	SS	AET660UD00-30DA98Z	v	v	v
1024MB	Aeneon	AET93F30DA	DS	AET760UD00-30DA98Z	v	v	v
512MB	Kingbox	EPD264082200-4KI0629	SS	N/A	v	v	v
1024MB	Kingbox	EPD264082200-4KI0629	DS	N/A	v	v	v



Obtain DDR DIMMs only from ASUS qualified vendors. Refer to the Qualified DDR2 533/667 vendors list on this page. Visit the ASUS website (www.asus.com) for the latest DDR2 Qualified Vendors List.

2.6.2 DIMM installation

To install a DDR2 DIMM:

1. Locate the four DIMM sockets on the motherboard.
2. Unlock a socket by pressing the retaining clips outward.

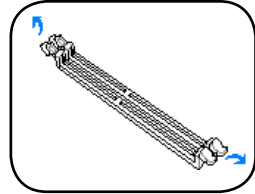

3. Align a DIMM on the socket such that the notch on the DIMM matches the break on the socket.

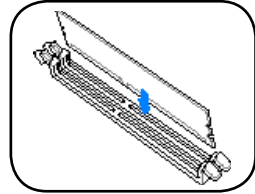

4. Firmly insert the DIMM into the socket until the retaining clips snap back in place and the DIMM is properly seated.

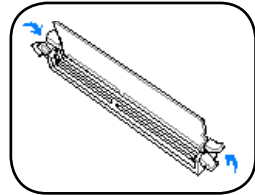

A DDR2 DIMM is keyed with a notch so that it fits in only one direction. DO NOT force a DIMM into a socket to avoid damaging the DIMM!

2.7 Installing an expansion card

In the future, you may need to install expansion cards. The motherboard has one PCI and one PCI Express™ x16 slot. The following sub-sections describe the slots and the expansion cards that they support.



Make sure to unplug the power cord before adding or removing expansion cards. Failure to do so may cause you physical injury and damage the motherboard.

2.7.1 Expansion slots

PCI slot

The PCI slots support PCI cards such as a LAN card, SCSI card, USB card, and other cards that comply with PCI specifications. The figure shows a LAN card installed on a PCI slot.

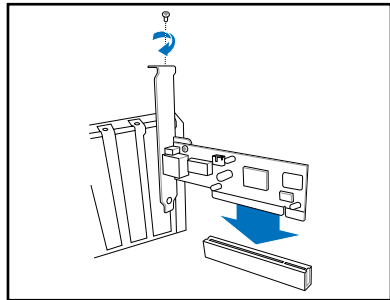

PCI Express™ x16 slot

This motherboard supports PCI Express™ x16 graphic cards that comply with PCI Express™ specifications. The figure shows a graphics card installed on the PCI Express™ x16 slot.

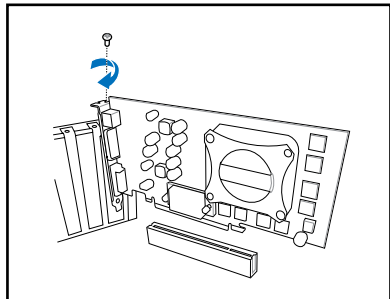

The chassis supports PCI Express x16 cards with 192mm x 19mm or smaller dimensions only.

2.7.2 Expansion card installation

To install an expansion card:

1. Before installing the expansion card, read the documentation that came with it and make the necessary hardware settings for the card.
2. Locate and remove one metal bracket lock screw.
3. Remove the metal bracket lock.
4. Align the card connector with the slot, then press firmly.
5. Secure the card with one screw.
6. Replace the metal bracket lock, then secure it with one screw.

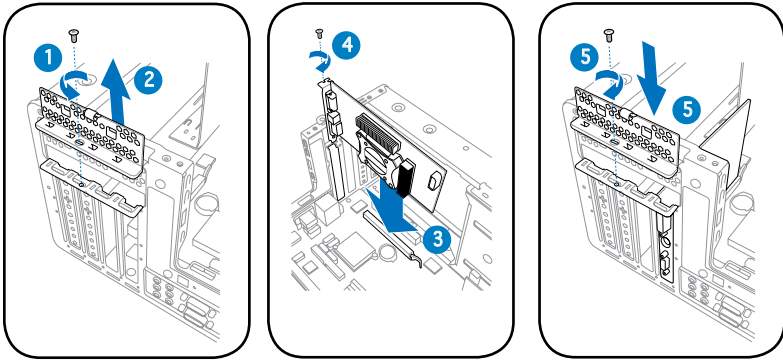

Standard interrupt assignments

IRQ	Standard Function
0	System Timer
1	Keyboard Controller
2	Programmable Interrupt
4	Communications Port (COM1)
6	Floppy Disk Controller
7*	Printer Port (LPT1)
8	System CMOS/Real Time Clock
9*	ACPI Mode when used
10*	IRQ Holder for PCI Steering
11*	IRQ Holder for PCI Steering
12*	PS/2 Compatible Mouse Port
13	Numeric Data Processor
14*	Primary IDE Channel

* These IRQs are usually available for ISA or PCI devices.

IRQ assignments for this motherboard

	A	B	C	D	E	F	G	H
PCI slot	--	--	--	--	--	shared	--	--
PCI Express x16 slot	shared	--	--	--	--	--	--	--
Onboard USB controller 1	--	--	--	--	shared	--	--	--
Onboard USB controller 2	--	shared	--	--	--	--	--	--
Onboard USB controller 3	--	--	shared	--	--	--	--	--
Onboard USB controller 4	--	--	--	shared	--	--	--	--
Onboard USB 2.0 controller	--	--	--	--	shared	--	--	--
Onboard IDE port	--	--	shared	--	--	--	--	--
Onboard AC' 97 Audio	shared	--	--	--	--	--	--	--
Onboard LAN	--	shared	--	--	--	--	--	--
Onboard 1394	--	--	--	--	--	shared	--	--



When using a PCI card on shared slots, ensure that the drivers support “Share IRQ” or that the cards do not need IRQ assignments; otherwise, conflicts will arise between the two PCI groups, making the system unstable and the card inoperable.

2.8 Installing an optical drive

The barebone system comes with a 5.25-inch drive bays for an optical drive.

To install an optical drive:

1. Place the chassis upright.
2. Insert the optical drive to the upper 5.25 in drive bay, then carefully push the drive until its screw holes align with the holes on the bay.
3. Secure the optical drive with four screws on both sides of the bay.
4. Connect the IDE and the power plugs to the connectors at the back of the drive.

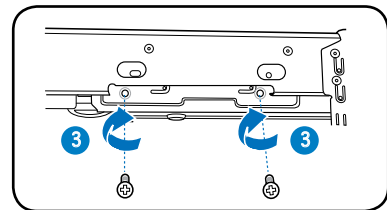
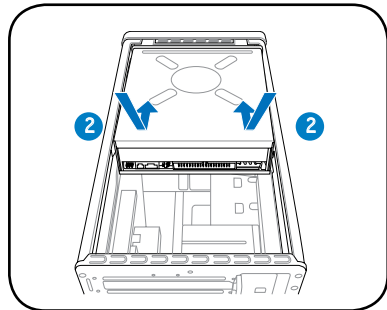

2.9 Installing a Serial ATA disk drive

The system supports one Serial ATA hard disk drive.

To install a Serial ATA hard disk drive:

1. Connect the SATA power cable to the plug of the power supply unit.
2. Connect the SATA signal cable and the power plugs to the connectors at the back of the drive.
3. Locate the HDD tray.
4. Insert a hard disk drive (with the HDD PCB facing the top of the chassis) to the tray, then secure it with four screws.
5. Connect the SATA signal cable to the SATA connector on the motherboard, and tighten all the cables with the plastic coils.

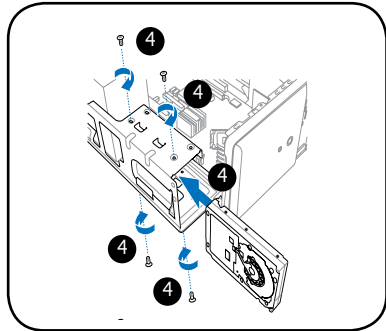
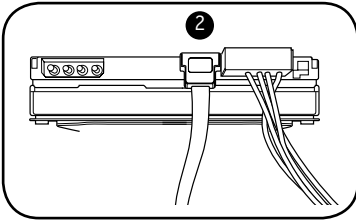
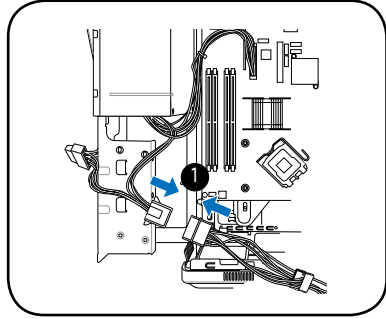

2.10 Reinstalling the power supply unit

Reinstall the power supply unit (PSU) after installing the system components and reconnecting the cables.

To reinstall the PSU:

1. If necessary, connect the 4-pin 12V power plug to the ATX12V connector on the motherboard.
2. If necessary, connect the 24-pin ATX power plug to the ATXPWR connector on the motherboard.
3. Connect the optical drive power connector.
4. Lift the PSU in the direction of the arrow until it properly fits in place.
5. Secure the PSU with the screws you removed earlier.

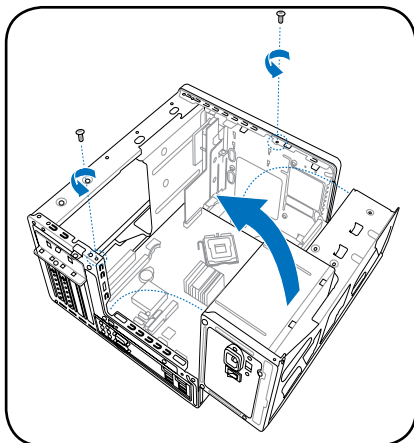

Make sure the PSU cables do not interfere with the CPU and/or chassis fans.

Voltage selector

The PSU has a 115 V/230 V voltage selector switch located beside the power connector. Use this switch to select the appropriate system input voltage according to the voltage supply in your area.

If the voltage supply in your area is 100-127 V, set the switch to 115 V.

If the voltage supply in your area is 200-240 V, set the switch to 230 V.

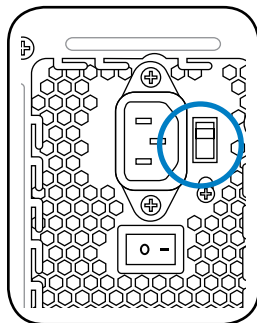

Setting the switch to 115 V in a 230 V environment will seriously damage the system!

2.11 Replacing the cover

To replace the cover:

1. Turn the chassis upright.
2. Position the front edge of the cover at least two inches from the front panel cover. Fit the cover tabs with the chassis rail and the front panel tabs.
3. Lower the rear edge of the cover as shown.
4. Push the cover slightly toward the front panel until it fits in place.
5. Secure the cover with the three screws you removed earlier.

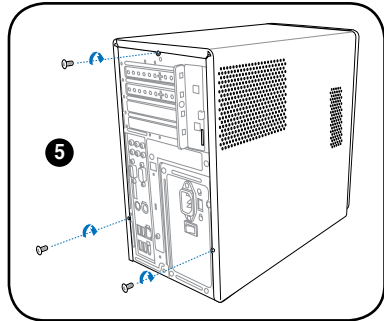
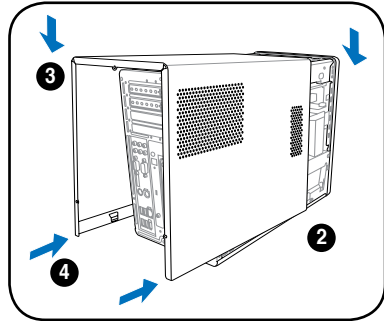

Chapter 3

This chapter helps you power up the system and install drivers and utilities from the support CD.

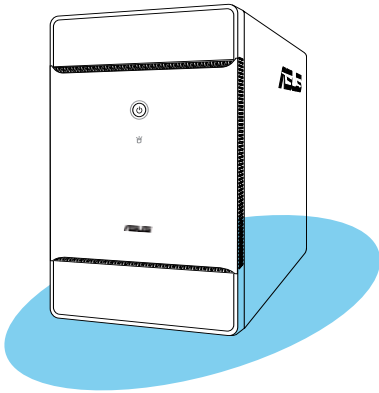

Starting up

3.1 Installing an operating system

The barebone system supports Windows® 2000/XP operating systems (OS). Always install the latest OS version and corresponding updates so you can maximize the features of your hardware.



Because motherboard settings and hardware options vary, use the setup procedures presented in this chapter for general reference only. Refer to your OS documentation for more information.

3.2 Powering up

The system power button is located on the front panel. Press the system power button (⏻) to enter the OS.

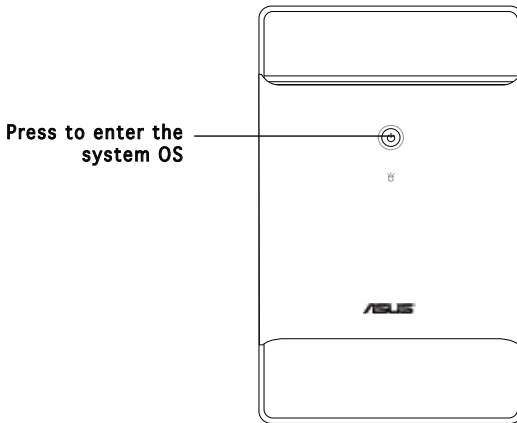

In Windows® OS, pressing the ⏻ button shuts down, restarts, or puts the system in sleep mode (S3) depending on the OS setting.

3.3 Support CD information

The support CD that came with the system contains useful software and several utility drivers that enhance the system features.



- Screen display and driver options may not be the same for other operating system versions.
- The contents of the support CD are subject to change at any time without notice. Visit the ASUS website for updates.

3.3.1 Running the support CD

To begin using the support CD, place the CD in your optical drive. The CD automatically displays the **Drivers** menu if Autorun is enabled in your computer.

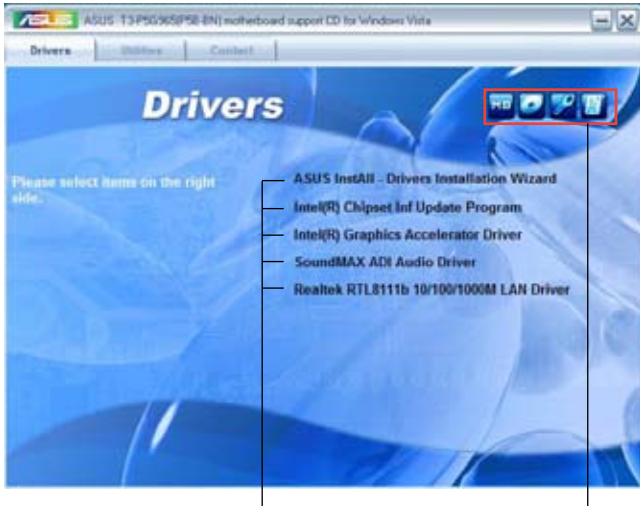

Click an item to install

Click an icon to display other information



If **Autorun** is NOT enabled in your computer, browse the contents of the support CD to locate the file **ASSETUP.EXE** from the BIN folder. Double-click the **ASSETUP.EXE** to run the CD.

3.3.2 Drivers menu

The drivers menu shows the available device drivers if the system detects installed devices. Install the necessary drivers to activate the devices.

ASUS InstAll - Drivers Installation Wizard

Allows you to easily install all necessary drivers for your system.

Intel(R) Chipset INF Update Program

Installs the Intel® Chipset INF Update Program.

Intel(R) Graphics Accelerator Driver

Installs the Intel® graphics accelerator driver.

SoundMAX ADI Audio Driver

Installs the SoundMAX® AC`97 audio driver.

Realtek RTL8111b 10/100/1000M LAN Driver

Installs the Realtek® 10/100/1000M LAN Driver.

3.3.3 Utilities menu

The Utilities menu shows the applications and other software that the motherboard supports.



ASUS InstAll - Installation Wizard for Utilities

Allows you to easily install all bundled utilities for this motherboard.

ASUS PC Probe II

This smart utility continuously monitors vital system information such as fan rotations, CPU temperature, and system voltages, and alerts you on any detected problems. This utility helps you keep your computer in a healthy operating condition.

ASUS Update

Installs the ASUS Update that allows you to update the motherboard BIOS and drivers. This utility requires an Internet connection either through a network or an Internet Service Provider (ISP). See page 5-8 for details.

Adobe Acrobat Reader V7.0

The Acrobat® Acrobat Reader® software is for viewing files saved in Portable Document Format (PDF).

ASUS Screensaver

Bring life to your idle screen by installing the ASUS Screensaver.

3.3.4 ASUS contact information

The Contact tab displays the ASUS contact information.

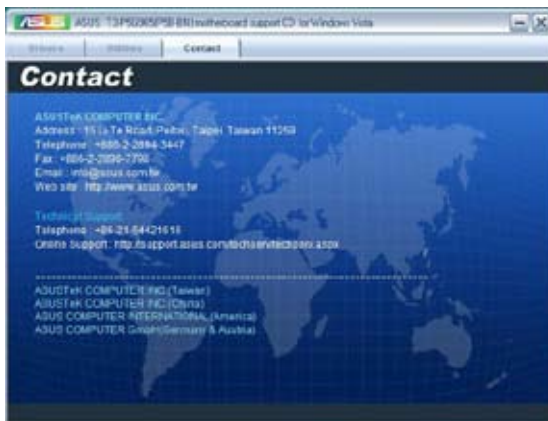

Chapter 4

This chapter gives information about the motherboard that comes with the system. This chapter includes the motherboard layout, jumper settings, and connector locations.

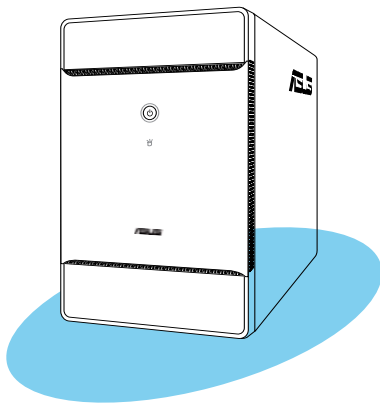

4.1 Introduction

The motherboard comes already installed in the ASUS T3-P5G965 system. This chapter provides technical information about the motherboard for future upgrades or system reconfiguration.

4.2 Motherboard layout

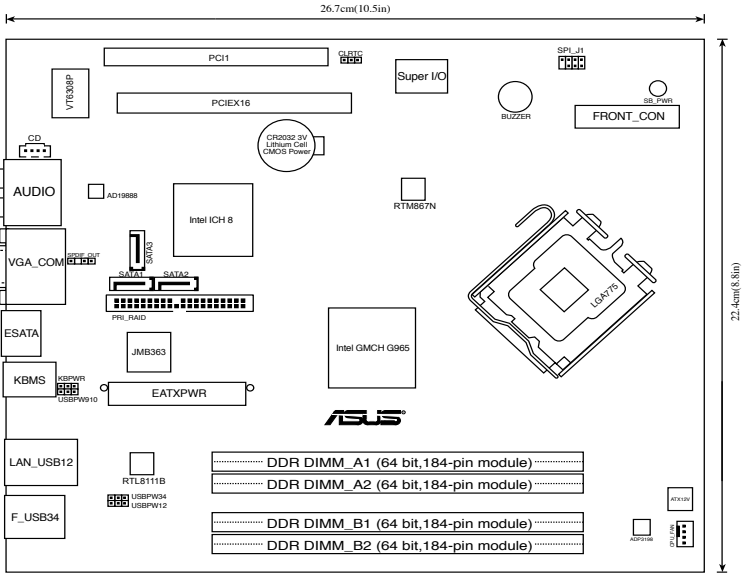

4.3 Jumpers

1. Clear RTC RAM (CLRRTC)

This jumper allows you to clear the Real Time Clock (RTC) RAM in CMOS. You can clear the CMOS memory of date, time, and system setup parameters by erasing the CMOS RTC RAM data. The onboard button cell battery powers the RAM data in CMOS, which include system setup information such as system passwords.

To erase the RTC RAM:

1. Turn OFF the computer and unplug the power cord.
2. Remove the onboard battery.
3. Move the jumper cap from pins 1-2 (default) to pins 2-3. Keep the cap on pins 2-3 for about 5~10 seconds, then move the cap back to pins 1-2.
4. Re-install the battery.
5. Plug the power cord and turn ON the computer.
6. Hold down the key during the boot process and enter BIOS setup to re-enter data.



Except when clearing the RTC RAM, never remove the cap on CLRRTC jumper default position. Removing the cap will cause system boot failure!

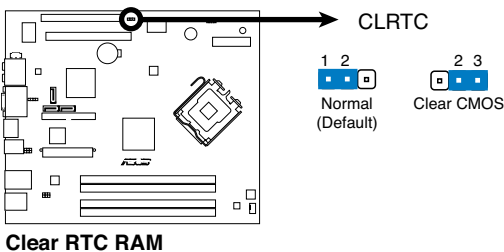

2. USB device wake-up (3-pin USBPW12, USBPW34, USBPW910)

Set these jumpers to +5V to wake up the computer from S1 sleep mode (CPU stopped, DRAM refreshed, system running in low power mode) using the connected USB devices. Set to +5VSB to wake up from S3 and S4 sleep modes (no power to CPU, DRAM in slow refresh, power supply in reduced power mode).

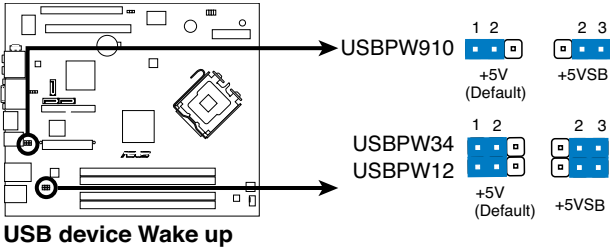

- The USB device wake-up feature requires a power supply that can provide 500mA on the +5VSB lead for each USB port; otherwise, the system would not power up.
- The total current consumed must NOT exceed the power supply capability (+5VSB) whether under normal condition or in sleep mode.

3. Keyboard power (3-pin KBPWR)

This jumper allows you to enable or disable the keyboard wake-up feature. Set this jumper to pins 2-3 (+5VSB) to wake up the computer when you press a key on the keyboard (the default is the Space Bar). This feature requires an ATX power supply that can supply at least 1A on the +5VSB lead, and a corresponding setting in the BIOS.

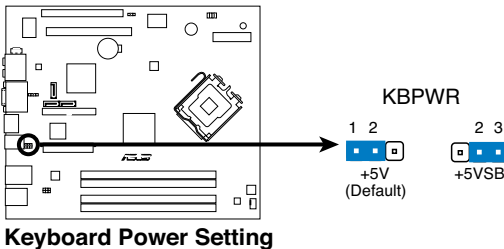

4.4 Connectors

This section describes and illustrates the connectors on the motherboard.

1. CPU fan connector (4-pin CPU_FAN)

The fan connector supports the proprietary CPU fan. Connect the fan cable to the fan connector on the motherboard, making sure that the black wire of each cable matches the ground pin of the connector.

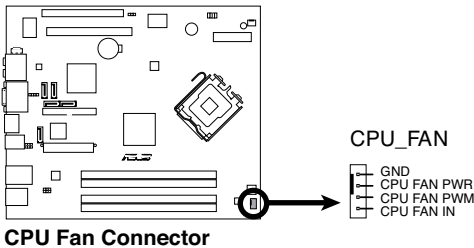

Do not forget to connect the fan cable to the fan connector. Insufficient air flow within the system may damage the motherboard components. These are not jumpers! DO NOT place jumper caps on the fan connectors!

2. ATX power connectors (24-pin EATXPWR, 4-pin ATX12V)

These connectors are for the 24-pin and 4-pin power plugs from the power supply unit. The plugs from the power supply unit are designed to fit these connectors in only one orientation. Find the proper orientation and push down firmly until the connectors completely fit.



Do not forget to connect the 4-pin ATX12V power plug to the ATX12V connector on the motherboard; otherwise, the system will not boot up.

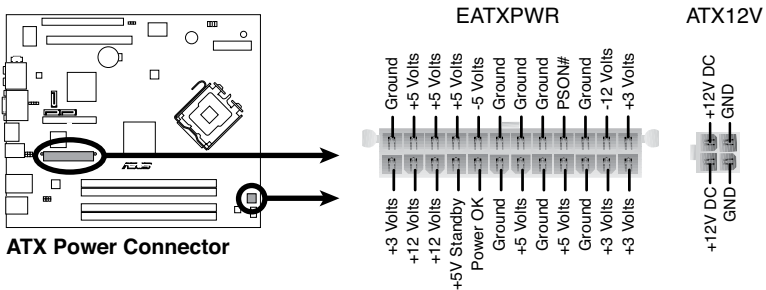

3. RAID connector (40-1 pin PRI_RAID)

This connector is for an Ultra DMA 100/66 signal cable. The Ultra DMA 100/66 signal cable has three connectors: a blue connector for the primary RAID connector on the motherboard, a black connector for an Ultra DMA 100/66 IDE slave device (optical drive/hard disk drive), and a gray connector for an Ultra DMA 100/66 RAID master device (hard disk drive). Refer to the hard disk documentation for the jumper settings.

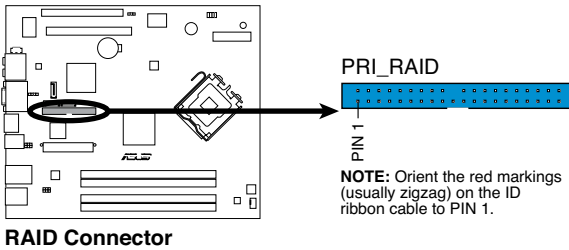

RAID Connector



- Pin 20 on the IDE connector is removed to match the covered hole on the Ultra DMA cable connector. This prevents incorrect insertion when you connect the IDE cable.
- Use the 80-conductor IDE cable for Ultra DMA 100/66 IDE devices.

4. Serial ATA connectors (7-pin SATA1, SATA2, SATA3)

These connectors are for the Serial ATA signal cables for Serial ATA hard disk drives.

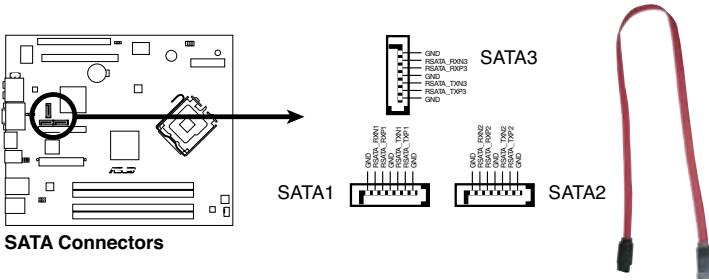

When using the connectors in Standard IDE mode, connect the primary (boot) hard disk drive to the SATA1/2 connector. Refer to the table below for the recommended SATA hard disk drive connections.

Serial ATA hard disk drive connection

Connector	Color	Setting	Use
SATA1/2	Red	Master	Boot disk
SATA3	Red	Slave	Data Disk



Connect the right-angle side of SATA signal cable to SATA device. Or you may connect the right-angle side of SATA cable to the onboard SATA port to avoid mechanical conflict with huge graphics cards.

right angle side

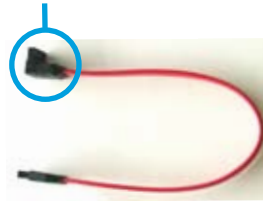

5. Digital audio connector (4-1 pin SPDIF_OUT)

This connector is for an additional Sony/Philips Digital Interface (S/PDIF) port(s). Connect the S/PDIF Out cable to this connector, then connect to the S/PDIF module of the system chassis.

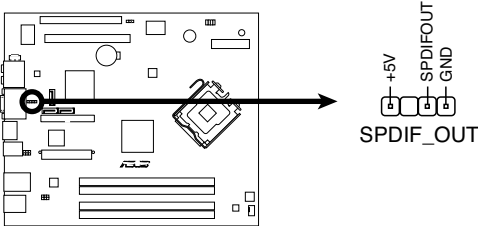

Digital Audio Connector

6. Optical drive audio connector (4-pin CD)

These connectors allow you to receive stereo audio input from sound sources such as a CD-ROM, TV tuner, or MPEG card.

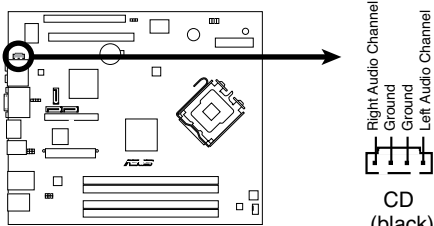

Internal Audio Connector

Chapter 5

This chapter tells how to change system settings through the BIOS Setup menus and describes the BIOS parameters.

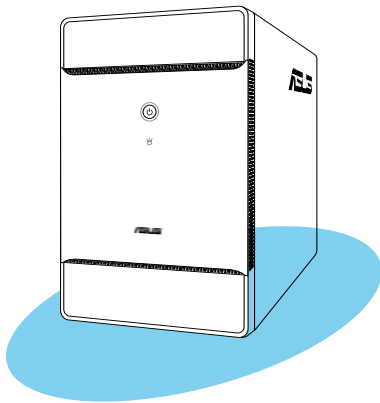

5.1 Managing and updating your BIOS

The following utilities allow you to manage and update the motherboard Basic Input/Output System (BIOS) setup.

1. **ASUS EZ Flash 2** (Updates the BIOS using a floppy disk, USB Flash, or the motherboard support CD during POST.)
2. **ASUS AFUDOS** (Updates the BIOS using a bootable floppy disk in DOS mode.)
3. **ASUS CrashFree BIOS 2** (Updates the BIOS using a bootable floppy disk or the motherboard support CD when the BIOS file fails or gets corrupted.)
4. **ASUS Update** (Updates the BIOS in Windows® environment.)

Refer to the corresponding sections for details on these utilities.



Save a copy of the original motherboard BIOS file to a bootable floppy disk in case you need to restore the BIOS in the future. Copy the original motherboard BIOS using the ASUS Update or AFUDOS utilities.

5.1.1 ASUS EZ Flash 2 utility

The ASUS EZ Flash 2 feature allows you to update the BIOS without having to go through the long process of booting from a floppy disk and using a DOS-based utility. The EZ Flash 2 utility is built-in the BIOS chip so it is accessible by pressing <Alt> + <F2> during the Power-On Self-Test (POST).

To update the BIOS using EZ Flash 2:

1. Visit the ASUS website (www.asus.com) to download the latest BIOS file for the motherboard.
2. Save the BIOS file to a floppy disk or a USB flash disk, then restart the system.
3. You can launch the EZ Flash 2 by two methods.
 - (1) Insert the floppy disk / USB flash disk that contains the BIOS file to the floppy disk drive or the USB port.

Press <Alt> + <F2> during POST to display the following.

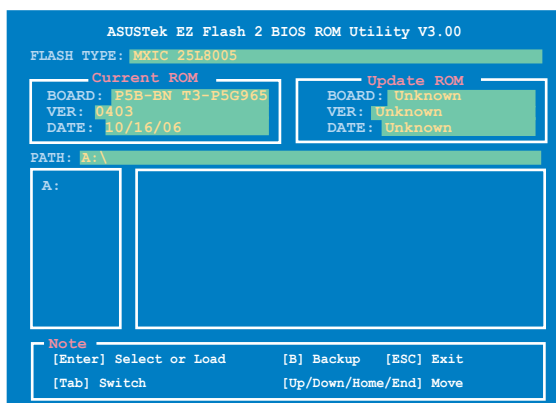

- (2) Enter BIOS setup program. Go to the Tools menu to select EZ Flash 2 and press <Enter> to enable it.

You can switch between drives by pressing <Tab> before the correct file is found. Then press <Enter>.

4. When the correct BIOS file is found, EZ Flash 2 performs the BIOS update process and automatically reboots the system when done.



- This function can support devices such as USB flash disk, or floppy disk with FAT 32/16 format only.
- Do not shut down or reset the system while updating the BIOS to prevent system boot failure!

5.1.2 AFUDOS utility

The AFUDOS utility allows you to update the BIOS file in DOS environment using a bootable floppy disk with the updated BIOS file. This utility also allows you to copy the current BIOS file that you can use as backup when the BIOS fails or gets corrupted during the updating process.

Copying the current BIOS

To copy the current BIOS file using the AFUDOS utility:



- Make sure that the floppy disk is not write-protected and has at least 600 KB free space to save the file.
- The succeeding BIOS screens are for reference only. The actual BIOS screen displays may not be exactly the same as shown.

1. Copy the AFUDOS utility (afudos.exe) from the motherboard support CD to the bootable floppy disk you created earlier.
2. Boot the system in DOS mode, then at the prompt type:

```
afudos /o[filename]
```

where the [filename] is any user-assigned filename not more than eight alphanumeric characters for the main filename and three alphanumeric characters for the extension name.

```
A:\>afudos /oOLDBIOS1.ROM
```

Main filename Extension name

3. Press <Enter>. The utility copies the current BIOS file to the floppy disk.

```
A:\>afudos /oOLDBIOS1.ROM
AMI Firmware Update Utility - Version 1.10
Copyright (C) 2002 American Megatrends, Inc. All rights reserved.
Reading flash ..... done
A:\>
```

The utility returns to the DOS prompt after copying the current BIOS file.

Updating the BIOS file

To update the BIOS file using the AFUDOS utility:

1. Visit the ASUS website (www.asus.com) and download the latest BIOS file for the motherboard. Save the BIOS file to a bootable floppy disk.



Write the BIOS filename on a piece of paper. You need to type the exact BIOS filename at the DOS prompt.

2. Copy the AFUDOS utility (afudos.exe) from the motherboard support CD to the bootable floppy disk you created earlier.
3. Boot the system in DOS mode, then at the prompt type:

```
afudos /i[filename]
```

where [filename] is the latest or the original BIOS file on the bootable floppy disk.

```
A:\>afudos /iP5BBN.ROM
```

4. The utility reads the file and starts updating the BIOS.

```
A:\>afudos /iP5BBN.ROM
AMI Firmware Update Utility - Version 1.19(ASUS V2.07(03.11.24BB))
Copyright (C) 2003 American Megatrends, Inc. All rights reserved.

WARNING!! Do not turn off power during flash BIOS
Reading file ..... done
Reading flash .... done
Search bootblock version
Advance Check.....
Erasing flash .... done
Writing flash .... 0x0008CC00 (9%)
```



Do not shut down or reset the system while updating the BIOS to prevent system boot failure!

5. The utility returns to the DOS prompt after the BIOS update process is completed. Reboot the system from the hard disk drive.

```
A:\>afudos /iP5BBN.ROM
AMI Firmware Update Utility - Version 1.19 (ASUS V2.07 (03.11.24BB))
Copyright (C) 2003 American Megatrends, Inc. All rights reserved.

WARNING!! Do not turn off power during flash BIOS
Reading file ..... done
Reading flash .... done
Search bootblock version
Advance Check.....
Erasing flash ..... done
Writing flash ..... done
Verifying flash ... done

Please restart your computer

A:\>
```

5.1.3 ASUS CrashFree BIOS 2 utility

The ASUS CrashFree BIOS 2 is an auto recovery tool that allows you to restore the BIOS file when it fails or gets corrupted during the updating process. You can update a corrupted BIOS file using the motherboard support CD or the floppy disk that contains the updated BIOS file.



- Prepare the motherboard support CD or the floppy disk containing the updated motherboard BIOS before using this utility.
- Make sure that you rename the original or updated BIOS file in the floppy disk to P5BBN.ROM.

Recovering the BIOS from a floppy disk

To recover the BIOS from a floppy disk:

1. Turn on the system.
2. Insert the floppy disk with the original or updated BIOS file to the floppy disk drive.

3. The utility displays the following message and automatically checks the floppy disk for the original or updated BIOS file.

```
Bad BIOS checksum. Starting BIOS recovery...
Checking for floppy...
```

When found, the utility reads the BIOS file and starts flashing the corrupted BIOS file.

```
Bad BIOS checksum. Starting BIOS recovery...
Checking for floppy...
Floppy found!
Reading file "P5BBN.ROM". Completed.
Start flashing...
```



DO NOT shut down or reset the system while updating the BIOS! Doing so can cause system boot failure!

4. Restart the system after the utility completes the updating process.

Recovering the BIOS from the support CD

To recover the BIOS from the support CD:

1. Remove any floppy disk from the floppy disk drive, then turn on the system.
2. Insert the support CD to the optical drive.
3. The utility displays the following message and automatically checks the floppy disk for the original or updated BIOS file.

```
Bad BIOS checksum. Starting BIOS recovery...
Checking for floppy...
```

When no floppy disk is found, the utility automatically checks the optical drive for the original or updated BIOS file. The utility then updates the corrupted BIOS file.

```
Bad BIOS checksum. Starting BIOS recovery...
Checking for floppy...
Floppy not found!
Checking for CD-ROM...
CD-ROM found!
Reading file "P5BBN.ROM". Completed.
Start flashing...
```



DO NOT shut down or reset the system while updating the BIOS! Doing so can cause system boot failure!

4. Restart the system after the utility completes the updating process.



The recovered BIOS may not be the latest BIOS version for this motherboard. Visit the ASUS website (www.asus.com) to download the latest BIOS file.

5.1.4 ASUS Update utility

The ASUS Update is a utility that allows you to manage, save, and update the motherboard BIOS in Windows® environment. The ASUS Update utility allows you to:

- Save the current BIOS file
- Download the latest BIOS file from the Internet
- Update the BIOS from an updated BIOS file
- Update the BIOS directly from the Internet, and
- View the BIOS version information.

This utility is available in the support CD that comes with the motherboard package.



ASUS Update requires an Internet connection either through a network or an Internet Service Provider (ISP).

Installing ASUS Update

To install ASUS Update:

1. Place the support CD in the optical drive. The Drivers menu appears.
2. Click the **Utilities** tab, then click **ASUS Update**. See page 3-4 for the **Utilities** screen menu.
3. The ASUS Update utility is copied to your system.



Quit all Windows® applications before you update the BIOS using this utility.

Updating the BIOS through the Internet

To update the BIOS through the Internet:

1. Launch the ASUS Update utility from the Windows® desktop by clicking **Start > Programs > ASUS > ASUSUpdate > ASUSUpdate**. The ASUS Update main window appears.

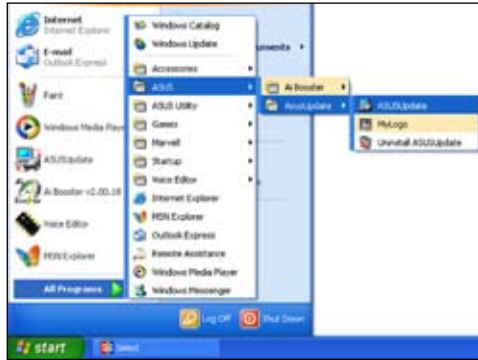

2. Select **Update BIOS from the Internet** option from the drop-down menu, then click **Next**.



3. Select the ASUS FTP site nearest you to avoid network traffic, or click **Auto Select**. Click **Next**.

- From the FTP site, select the BIOS version that you wish to download. Click **Next**.
- Follow the screen instructions to complete the update process.



The ASUS Update utility is capable of updating itself through the Internet. Always update the utility to avail all its features.



Updating the BIOS through a BIOS file

To update the BIOS through a BIOS file:

- Launch the ASUS Update utility from the Windows® desktop by clicking **Start > Programs > ASUS > ASUSUpdate > ASUSUpdate**. The ASUS Update main window appears.
- Select **Update BIOS from a file** option from the drop-down menu, then click Next.



- Locate the BIOS file from the **Open** window, then click **Open**.
- Follow the screen instructions to complete the update process.

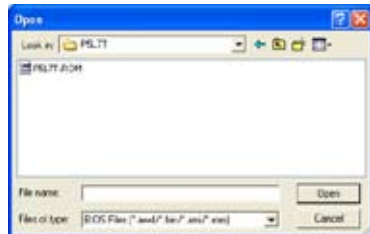

5.2 BIOS setup program

This motherboard supports a programmable Low-Pin Count (LPC) chip that you can update using the provided utility described in section “4.1 Managing and updating your BIOS.”

Use the BIOS Setup program when you are installing a motherboard, reconfiguring your system, or prompted to “Run Setup.” This section explains how to configure your system using this utility.

Even if you are not prompted to use the Setup program, you can change the configuration of your computer in the future. For example, you can enable the security password feature or change the power management settings. This requires you to reconfigure your system using the BIOS Setup program so that the computer can recognize these changes and record them in the CMOS RAM of the LPC chip.

The LPC chip on the motherboard stores the Setup utility. When you start up the computer, the system provides you with the opportunity to run this program. Press during the Power-On Self-Test (POST) to enter the Setup utility; otherwise, POST continues with its test routines.

If you wish to enter Setup after POST, reboot the system by doing any of the following procedures:

- **Restart using the OS standard shut-down procedure.**
- **Press <Ctrl>+<Alt>+ simultaneously.**
- **Press the reset button on the system chassis.**
- **Press the power button to turn the system off then back on.**



Using the power button, reset button, or the <Ctrl>+<Alt>+ keys to force reset from a running operating system can cause damage to your data or system. We recommend to always shut-down the system properly from the operating system.

The Setup program is designed to make it as easy to use as possible. Being a menu-driven program, it lets you scroll through the various sub-menus and make your selections from the available options using the navigation keys.



- The default BIOS settings for this motherboard apply for most conditions to ensure optimum performance. If the system becomes unstable after changing any BIOS settings, load the default settings to ensure system compatibility and stability. Select the Load Default Settings item under the Exit Menu. See section “5.8 Exit Menu.”
 - The BIOS setup screens shown in this section are for reference purposes only, and may not exactly match what you see on your screen.
 - Visit the ASUS website (www.asus.com) to download the latest BIOS file for this motherboard.
-

5.2.1 BIOS menu screen

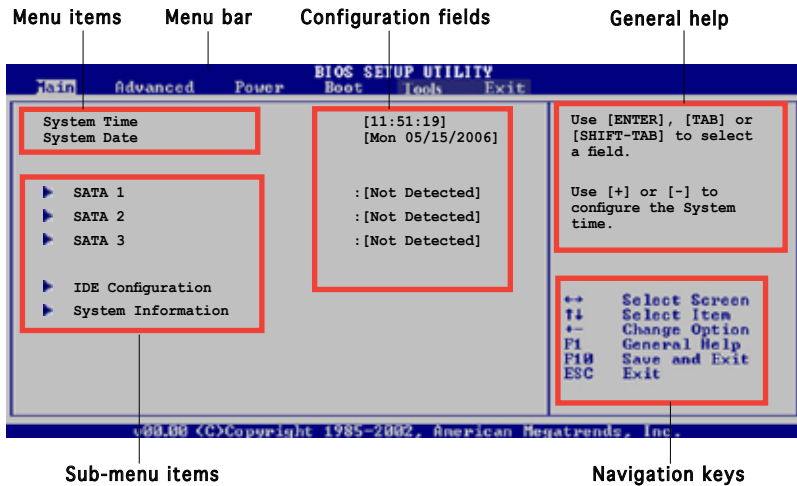

5.2.2 Menu bar

The menu bar on top of the screen has the following main items:

- Main** For changing the basic system configuration
- Advanced** For changing the advanced system settings
- Power** For changing the advanced power management (APM) configuration
- Boot** For changing the system boot configuration
- Tools** For setting EZ Flash 2 and O.C. Profile.
- Exit** For selecting the exit options and loading default settings

To select an item on the menu bar, press the right or left arrow key on the keyboard until the desired item is highlighted.

5.2.3 Navigation keys

At the bottom right corner of a menu screen are the navigation keys for that particular menu. Use the navigation keys to select items in the menu and change the settings.



Some of the navigation keys differ from one screen to another.

5.2.4 Menu items

The highlighted item on the menu bar displays the specific items for that menu. For example, selecting Main shows the Main menu items.

The other items (Advanced, Power, Boot, Tools and Exit) on the menu bar have their respective menu items.

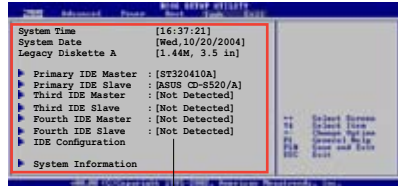

Main menu items

5.2.5 Sub-menu items

A solid triangle before each item on any menu screen means that the item has a sub-menu. To display the sub-menu, select the item and press <Enter>.

5.2.6 Configuration fields

These fields show the values for the menu items. If an item is user-configurable, you can change the value of the field opposite the item. You cannot select an item that is not user-configurable.

A configurable field is enclosed in brackets, and is highlighted when selected. To change the value of a field, select it then press <Enter> to display a list of options. Refer to “5.2.7 Pop-up window.”

5.2.7 Pop-up window

Select a menu item then press <Enter> to display a pop-up window with the configuration options for that item.

5.2.8 Scroll bar

A scroll bar appears on the right side of a menu screen when there are items that do not fit on the screen. Press the Up/Down arrow keys or <Page Up> / <Page Down> keys to display the other items on the screen.

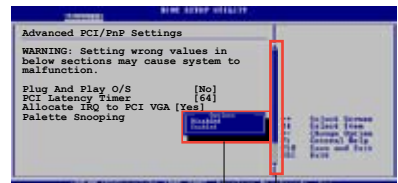

Pop-up window

Scroll bar

5.2.9 General help

At the top right corner of the menu screen is a brief description of the selected item.

5.3 Main menu

When you enter the BIOS Setup program, the Main menu screen appears, giving you an overview of the basic system information.



Refer to section “5.2.1 BIOS menu screen” for information on the menu screen items and how to navigate through them.



5.3.1 System Time [xx:xx:xx]

Allows you to set the system time.

5.3.2 System Date [Day xx/xx/xxxx]

Allows you to set the system date.

5.3.3 SATA1, SATA2, and SATA3

While entering Setup, the BIOS automatically detects the presence of IDE devices. There is a separate sub-menu for each IDE device. Select a device item then press <Enter> to display the IDE device information.

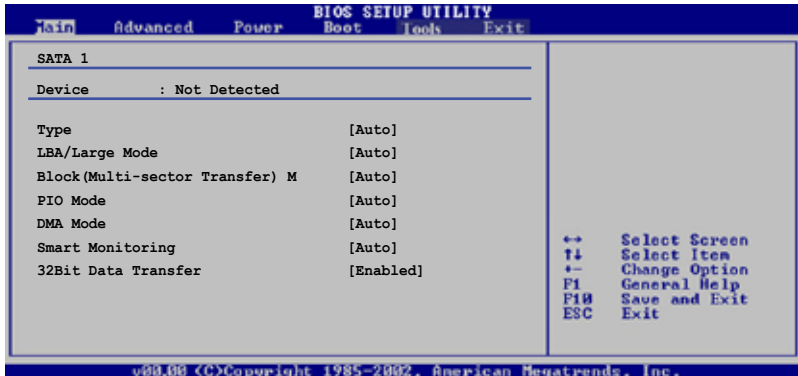

The BIOS automatically detects the values opposite the dimmed items (Device, Vendor, Size, LBA Mode, Block Mode, PIO Mode, Async DMA, Ultra DMA, and SMART monitoring). These values are not user-configurable. These items show N/A if no IDE device is installed in the system.

Type [Auto]

Selects the type of IDE drive. Setting to Auto allows automatic selection of the appropriate IDE device type. Select CDROM if you are specifically configuring a CD-ROM drive. Select ARMD (ATAPI Removable Media Device) if your device is either a ZIP, LS-120, or MO drive. Configuration options: [Not Installed] [Auto] [CDROM] [ARMD]

LBA/Large Mode [Auto]

Enables or disables the LBA mode. Setting to Auto enables the LBA mode if the device supports this mode, and if the device was not previously formatted with LBA mode disabled. Configuration options: [Disabled] [Auto]

Block (Multi-sector Transfer) M [Auto]

Enables or disables data multi-sectors transfers. When set to Auto, the data transfer from and to the device occurs multiple sectors at a time if the device supports multi-sector transfer feature. When set to [Disabled], the data transfer from and to the device occurs one sector at a time. Configuration options: [Disabled] [Auto]

PIO Mode [Auto]

Selects the PIO mode.

Configuration options: [Auto] [0] [1] [2] [3] [4]

DMA Mode [Auto]

Selects the DMA mode. Configuration options: [Auto] [SWDMA0]

[SWDMA1] [SWDMA2] [MWDMA0] [MWDMA1] [MWDMA2] [UDMA0]

[UDMA1] [UDMA2] [UDMA3] [UDMA4] [UDMA5]

SMART Monitoring [Auto]

Sets the Smart Monitoring, Analysis, and Reporting Technology.

Configuration options: [Auto] [Disabled] [Enabled]

32Bit Data Transfer [Enabled]

Enables or disables 32-bit data transfer.

Configuration options: [Disabled] [Enabled]

5.3.4 IDE Configuration

The items in this menu allow you to set or change the configurations for the IDE devices installed in the system. Select an item then press <Enter> if you want to configure the item.

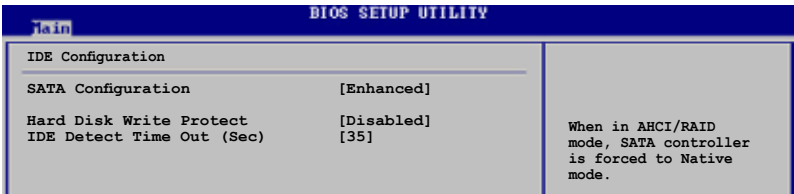

SATA Configuration [Enhanced]

Configuration options: [Compatible] [Enhanced] [Disabled]

Configure SATA as [IDE]

Configuration options: [IDE] [AHCI]

Hard Disk Write Protect [Disabled]

Allows you to enable to disable the hard disk write protection. This will be effective only if device is accessed through BIOS. Configuration options: [Disabled] [Enabled]

IDE Detect Time Out [35]

Selects the time out value for detecting ATA/ATAPI devices.

Configuration options: [0] [5] [10] [15] [20] [25] [30] [35]

5.3.5 System Information

This menu gives you an overview of the general system specifications. The BIOS automatically detects the items in this menu.



AMI BIOS

Displays the auto-detected BIOS information.

Processor

Displays the auto-detected CPU specification.

System Memory

Displays the auto-detected system memory.

5.4 Advanced menu

The Advanced menu items allow you to change the settings for the CPU and other system devices.



Take caution when changing the settings of the Advanced menu items. Incorrect field values can cause the system to malfunction.

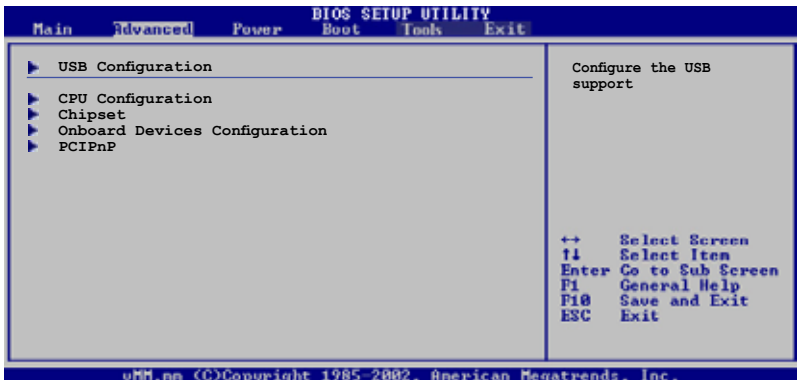

5.4.1 USB Configuration

The items in this menu allow you to change the USB-related features. Select an item then press <Enter> to display the configuration options.

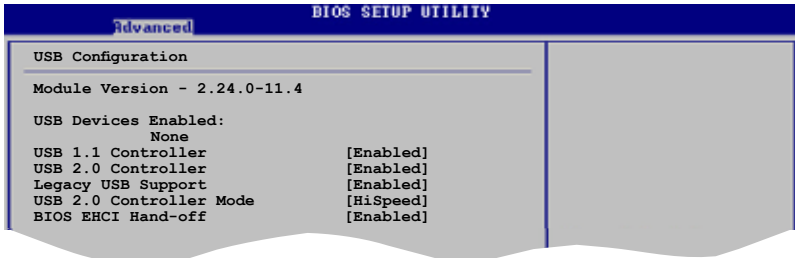

The Module Version and USB Devices Enabled items show the auto-detected values. If no USB device is detected, the item shows None.

USB 1.1 Controller [Enabled]

Allows you to enable or disable the USB 1.1 controller.
Configuration options: [Enabled] [Disabled]

USB 2.0 Controller [Enabled]

Allows you to enable or disable the USB 2.0 controller.
Configuration options: [Enabled] [Disabled]

Legacy USB Support [Enabled]

Allows you to enable or disable support for USB devices on legacy operating systems (OS). Setting to Auto allows the system to detect the presence of USB devices at startup. If detected, the USB controller legacy mode is enabled. If no USB device is detected, the legacy USB support is disabled. Configuration options: [Disabled] [Enabled] [Auto]

USB 2.0 Controller Mode [HiSpeed]

Allows you to set the USB 2.0 controller mode to HiSpeed (480 Mbps) or FullSpeed (12 Mbps). Configuration options: [FullSpeed] [HiSpeed]

BIOS EHCI Hand-off [Enabled]

Allows you to enable or disable the enhanced host controller interface (EHCI) hand-off support. This is a workaround for operating systems without EHCI hand-off support. The ECHI ownership change should be claimed by the EHCI driver. Configuration options: [Disabled] [Enabled]

5.4.2 CPU Configuration

The items in this menu show the CPU-related information that the BIOS automatically detects.

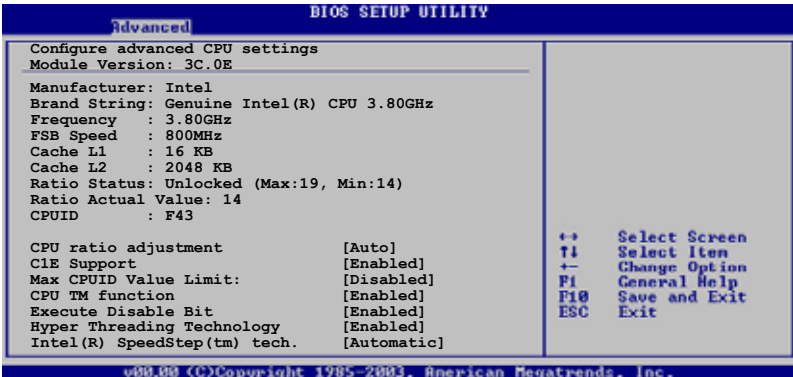

CPU ratio adjustment [Auto]

Sets the ratio between the CPU Core Clock and the Front Side Bus frequency. The default value of this item is auto-detected by BIOS. Use the <+> or <-> keys to adjust the values.

C1E Support [Enabled]

Allows you to enable or disable the C1E support. In C1E mode, the CPU power consumption is lower than idle. Configuration options: [Disabled] [Enabled]

Max CPUID Value Limit [Disabled]

Enable this item to boot legacy operating systems that cannot support CPUs with extended CPUID functions. Configuration options: [Disabled] [Enabled]

CPU TM function [Enabled]

Allows you to enable or disable the CPU internal thermal control function. In TM mode, the CPU power consumption is reduced. Configuration options: [Disabled] [Enabled]

Execute Disable Function [Enabled]

Allows you to enable or disable Execute Disable Function. Configuration options: [Disabled] [Enabled]

Hyper Threading Technology [Enabled]

Enables or disables the processor Hyper-Threading Technology.
Configuration options: [Disabled] [Enabled]

Intel(R) SpeedStep(tm) Technology [Automatic]

Allows you to use the Enhanced Intel® SpeedStep® Technology. When set to [Enabled], you can adjust the system power settings in the operating system to use the EIST feature. Set this item to [Disabled] if you do not want to use the EIST. Configuration options: [Automatic] [Disabled]

5.4.3 Chipset

The Chipset menu allows you to change the advanced chipset settings. Select an item then press <Enter> to display the sub-menu.

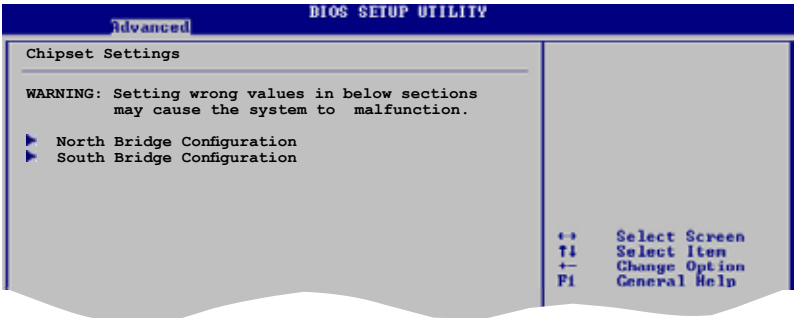

North Bridge Configuration

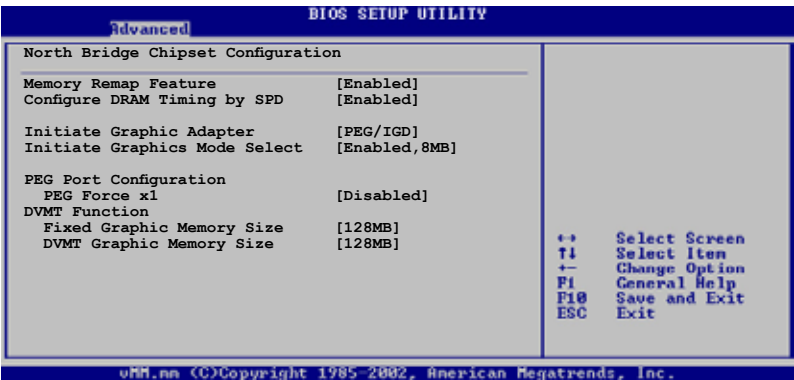

Memory Remap Feature [Enabled]

Allows you to enable or disable Memory Remap Feature.

Configuration options: [Disabled] [Enabled]

Configure DRAM Timing by SPD [Enabled]

Allows you to Configure DRAM Timing by SPD.

Configuration options: [Disabled] [Enabled]

Initiate Graphic Adapter [PEG/IGD]

Allows you to select Initiate Graphic Adapter.

Configuration options: [IGD] [PCI/IGD] [PCI/PEG] [PEG/IGD] [PEG/PCI]

Initiate Graphics Mode Select [Enabled,8MB]

Allows you to select the amount of system memory used by the Internal graphics device.

Configuration options: [Disabled] [Enabled,1MB] [Enabled,8MB]

PEG Force x1 [Disabled]

Allows you to set PEG Force x1 configuration.

Configuration options: [Disabled] [Enabled]

Fixed Graphic Memory Size [128MB]

Allows you to select the size of graphic memory used by fixed mode.

Configuration options: [0MB] [64MB] [128MB]

DVMT Graphic Memory Size [128MB]

Allows you to select the size of graphic memory used by DVMT mode.

Configuration options: [0MB] [64MB] [128MB] [224MB]

South Bridge Configuration



HD Audio Controller [Enabled]

Allows you to enable or disable high definition audio controller.

Configuration options: [Disabled] [Enabled]

CPU Throttling Duty [Disable]

Allows you to configure CPU Throttling Duty.

Configuration options: [Disable] [25%] [50%] [70%]

5.4.4 Onboard Devices Configuration

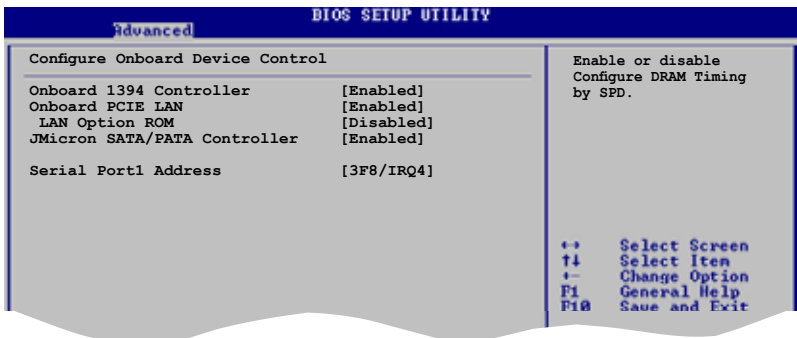

Onboard 1394 Controller [Enabled]

Enables or disables the onboard IEEE 1394a controller.

Configuration options: [Enabled] [Disabled]

OnBoard PCIE LAN [Enabled]

Allows you to enable or disable the onboard PCI Express LAN controller.
Configuration options: [Enabled] [Disabled]

LAN Option ROM [Disabled]

Allows you to enable or disable the option ROM in the onboard PCI Express Gigabit LAN controller. This item appears only when the Onboard PCIE GbE LAN item is set to Enabled.
Configuration options: [Disabled] [Enabled]

JMicron SATA/PATA Controller [Enabled]

Allows you to enable or disable the JMicron SATA/PATA controller.
Configuration options: [Disabled] [Enabled]

Serial Port1 Address [3F8/IRQ4]

Allows you to select the Serial Port1 base address.
Configuration options: [Disabled] [3F8/IRQ4] [2F8/IRQ3] [3E8/IRQ4] [2E8/IRQ3]

5.4.5 PCI PnP

The PCI PnP menu items allow you to change the advanced settings for PCI/PnP devices. The menu includes setting IRQ and DMA channel resources for either PCI/PnP or legacy ISA devices, and setting the memory size block for legacy ISA devices.



Take caution when changing the settings of the PCI PnP menu items. Incorrect field values can cause the system to malfunction.



Plug and Play O/S [No]

When set to [No], BIOS configures all the devices in the system. When set to [Yes] and if you install a Plug and Play operating system, the operating system configures the Plug and Play devices not required for boot. Configuration options: [No] [Yes]

PCI Latency Timer [64]

Allows you to select the value in units of PCI clocks for the PCI device latency timer register. Configuration options: [32] [64] [96] [128] [160] [192] [224] [248]

Allocate IRQ to PCI VGA [Yes]

When set to [Yes], BIOS assigns an IRQ to PCI VGA card if the card requests for an IRQ. When set to [No], BIOS does not assign an IRQ to the PCI VGA card even if requested. Configuration options: [Yes] [No]

Palette Snooping [Disabled]

When set to [Enabled], the palette snooping feature informs the PCI devices that an ISA graphics device is installed in the system so that the latter can function correctly. Configuration options: [Disabled] [Enabled]

IRQ-XX assigned to [PCI Device]

When set to [PCI Device], the specific IRQ is free for use of PCI/PnP devices. When set to [Reserved], the IRQ is reserved for legacy ISA devices. Configuration options: [PCI Device] [Reserved]

5.5 Power menu

The Power menu items allow you to change the settings for the ACPI and Advanced Power Management (APM). Select an item then press <Enter> to display the configuration options.



5.5.1 Suspend Mode [Auto]

Allows you to select the Advanced Configuration and Power Interface (ACPI) state to be used for system suspend.

Configuration options: [S1 (POS) Only] [S3 Only] [Auto]

5.5.2 Repost Video on S3 Resume [Disabled]

Allows you to determine whether to invoke VGA BIOS POST on S3/STR resume. Configuration options: [Disabled] [Enabled]

5.5.3 ACPI 2.0 Support [Disabled]

Allows you to add more tables for Advanced Configuration and Power Interface (ACPI) 2.0 specifications.

Configuration options: [Disabled] [Enabled]

5.5.4 ACPI APIC Support [Enabled]

Allows you to enable or disable the Advanced Configuration and Power Interface (ACPI) support in the Advanced Programmable Interrupt Controller (APIC). When set to Enabled, the ACPI APIC table pointer is included in the RSDT pointer list. Configuration options: [Disabled] [Enabled]

5.5.5 APM Configuration

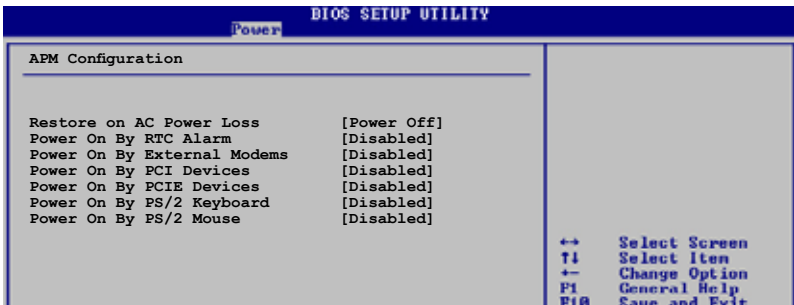

Restore on AC Power Loss [Power Off]

When set to Power Off, the system goes into off state after an AC power loss. When set to Power On, the system goes on after an AC power loss. When set to Last State, the system goes into either off or on state, whatever the system state was before the AC power loss. Configuration options: [Power Off] [Power On] [Last State]

Power On By RTC Alarm [Disabled]

Allows you to enable or disable RTC to generate a wake event. When this item is set to Enabled, the items RTC Alarm Date, RTC Alarm Hour, RTC Alarm Minute, and RTC Alarm Second appear with set values. Configuration options: [Disabled] [Enabled]

Power On By External Modems [Disabled]

This allows either settings of [Enabled] or [Disabled] for powering up the computer when the external modem receives a call while the computer is in Soft-off mode. Configuration options: [Disabled] [Enabled]

Power On By PCIE Devices [Disabled]

When set to [Enabled], this parameter allows you to turn on the system through a PCI LAN, modem card, or PCI Express device. This feature requires an ATX power supply that provides at least 1A on the +5VSB lead. Configuration options: [Disabled] [Enabled]

Power On By PCIE Devices [Disabled]

When set to [Enabled], this parameter allows you to turn on the system through a PCI LAN, modem card, or PCI Express device. This feature requires an ATX power supply that provides at least 1A on the +5VSB lead. Configuration options: [Disabled] [Enabled]



The computer cannot receive or transmit data until the computer and applications are fully running. Thus, connection cannot be made on the first try. Turning an external modem off and then back on while the computer is off causes an initialization string that turns the system on.

Power On By PS/2 Keyboard [Disabled]

Allows you to use specific keys on the keyboard to turn on the system. This feature requires an ATX power supply that provides at least 1A on the +5VSB lead. Configuration options: [Disabled] [Space Bar] [Ctrl-Esc] [Power Key]

Power On By PS/2 Mouse [Disabled]

When set to [Enabled], this parameter allows you to use the PS/2 mouse to turn on the system. This feature requires an ATX power supply that provides at least 1A on the +5VSB lead. Configuration options: [Disabled] [Enabled]

5.5.6 Hardware Monitor

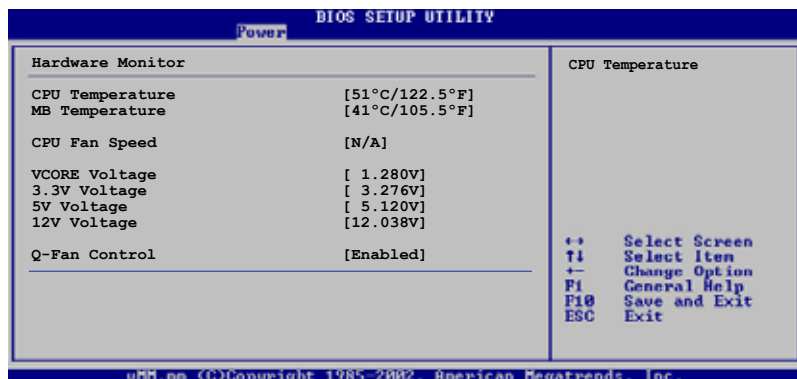

CPU Temperature [xxx°C/xxx°F]

MB Temperature [xxx°C/xxx°F]

The onboard hardware monitor automatically detects and displays the motherboard and CPU temperatures. Select Disabled if you do not wish to display the detected temperatures.

CPU Fan Speed [xxxxRPM], [N/A], or [Ignored]

The onboard hardware monitor automatically detects and displays the CPU fan speed in rotations per minute (RPM). If the fan is not connected to the motherboard, the field shows N/A.

VCORE Voltage, 3.3V Voltage, 5V Voltage, 12V Voltage

The onboard hardware monitor automatically detects the voltage output through the onboard voltage regulators.

CPU Q-Fan Control [Enabled]

Allows you to enable or disable the ASUS Q-Fan feature that smartly adjusts the fan speeds for more efficient system operation. When this field is set to [Enabled], the three succeeding items appear. Configuration options: [Disabled] [Enabled]

5.6 Boot menu

The Boot menu items allow you to change the system boot options. Select an item then press <Enter> to display the sub-menu.



5.6.1 Boot Device Priority

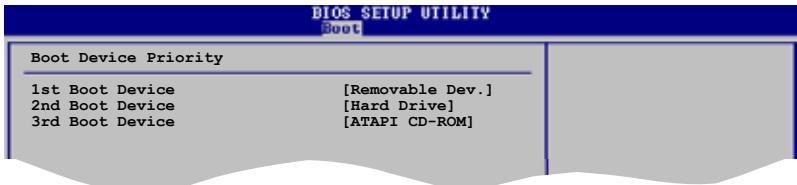

1st ~ xxth Boot Device

These items specify the boot device priority sequence from the available devices. The number of device items that appears on the screen depends on the number of devices installed in the system.

Configuration options: [Removable Dev.] [Hard Drive] [ATAPI CD-ROM] [Disabled]

5.6.2 Boot Settings Configuration

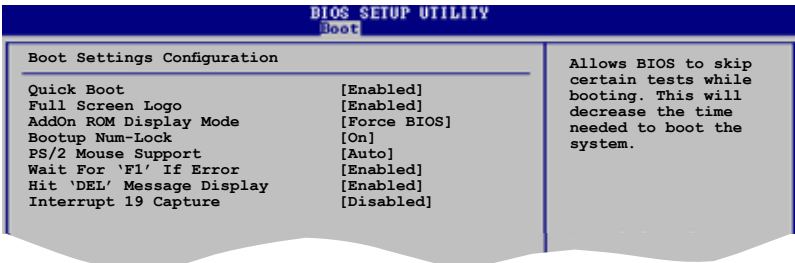

Quick Boot [Enabled]

Enabling this item allows the BIOS to skip some power on self tests (POST) while booting to decrease the time needed to boot the system. When set to [Disabled], BIOS performs all the POST items.

Configuration options: [Disabled] [Enabled]

Full Screen Logo [Enabled]

This allows you to enable or disable the full screen logo display feature.

Configuration options: [Disabled] [Enabled]



Set this item to [Enabled] to use the ASUS MyLogo2™ feature.

Add On ROM Display Mode [Force BIOS]

Sets the display mode for option ROM.

Configuration options: [Force BIOS] [Keep Current]

Bootup Num-Lock [On]

Allows you to select the power-on state for the NumLock.

Configuration options: [Off] [On]

PS/2 Mouse Support [Auto]

Allows you to enable or disable support for PS/2 mouse.

Configuration options: [Disabled] [Enabled] [Auto]

Wait for 'F1' If Error [Enabled]

When set to Enabled, the system waits for the F1 key to be pressed when error occurs. Configuration options: [Disabled] [Enabled]

Hit 'DEL' Message Display [Enabled]

When set to Enabled, the system displays the message “Press DEL to run Setup” during POST. Configuration options: [Disabled] [Enabled]

Interrupt 19 Capture [Disabled]

When set to [Enabled], this function allows the option ROMs to trap Interrupt 19. Configuration options: [Disabled] [Enabled]

5.6.3 Security

The Security menu items allow you to change the system security settings. Select an item then press <Enter> to display the configuration options.

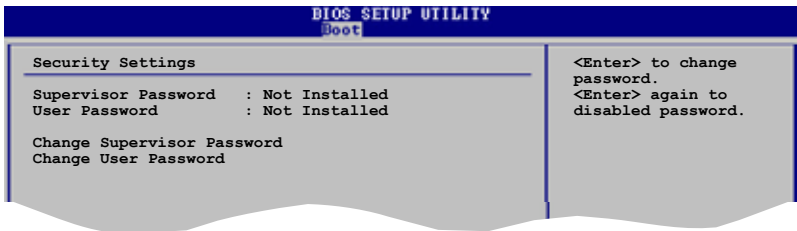

Change Supervisor Password

Select this item to set or change the supervisor password. The Supervisor Password item on top of the screen shows the default **Not Installed**. After you set a password, this item shows **Installed**.

To set a Supervisor Password:

1. Select the **Change Supervisor Password** item and press <Enter>.
2. From the password box, type a password composed of at least six letters and/or numbers, then press <Enter>.
3. Confirm the password when prompted.

The message “Password Installed” appears after you successfully set your password.

To change the supervisor password, follow the same steps as in setting a user password.

To clear the supervisor password, select the **Change Supervisor Password** then press <Enter>. The message “Password Uninstalled” appears.



If you forget your BIOS password, you can clear it by erasing the CMOS Real Time Clock (RTC) RAM. See section “4.3 Jumpers” for information on how to erase the RTC RAM.

After you have set a supervisor password, the other items appear to allow you to change other security settings.

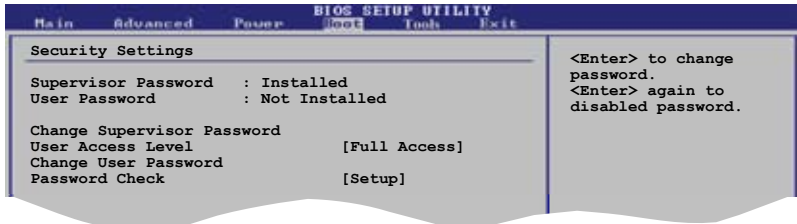

User Access Level [Full Access]

This item allows you to select the access restriction to the Setup items. Configuration options: [No Access] [View Only] [Limited] [Full Access]

No Access prevents user access to the Setup utility.

View Only allows access but does not allow change to any field.

Limited allows changes only to selected fields, such as Date and Time.

Full Access allows viewing and changing all the fields in the Setup utility.

Change User Password

Select this item to set or change the user password. The User Password item on top of the screen shows the default **Not Installed**. After you set a password, this item shows Installed.

To set a User Password:

1. Select the **Change User Password** item and press <Enter>.
2. On the password box that appears, type a password composed of at least six letters and/or numbers, then press <Enter>.
3. Confirm the password when prompted.

The message “Password Installed” appears after you set your password successfully.

To change the user password, follow the same steps as in setting a user password.

Clear User Password

Select this item to clear the user password.

Password Check [Setup]

When set to [Setup], BIOS checks for user password when accessing the Setup utility. When set to [Always], BIOS checks for user password both when accessing Setup and booting the system. Configuration options: [Setup] [Always]

5.7 Tools menu



5.7.1 ASUS EZ Flash 2

Allows you to run ASUS EZ Flash 2. When you press <Enter>, a confirmation message appears. Use the left/right arrow key to select between [Yes] or [No], then press <Enter> to confirm your choice. See page 5-2, section 5.1.2 for details.

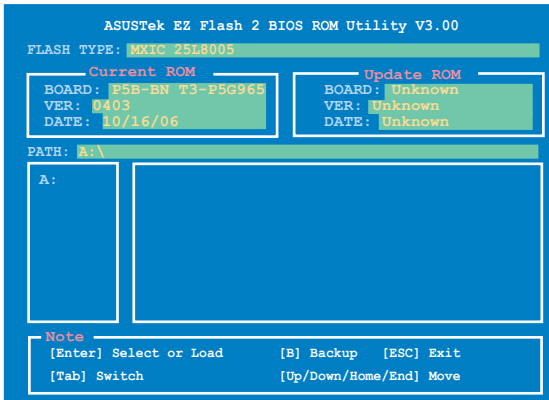

5.7.2 ASUS O.C. Profile

This item allows you to store or load multiple BIOS settings.

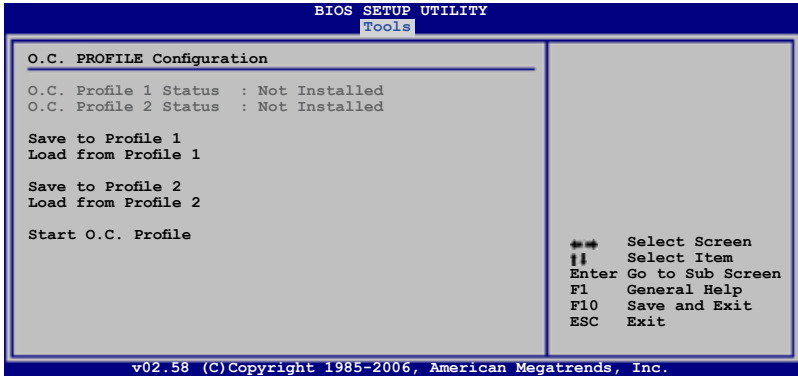

Save to Profile 1/2

Allows you to save the current BIOS file to the BIOS Flash. Press <Enter> to save the file.

Load from Profile 1/2

Allows you to load the previous BIOS settings saved in the BIOS Flash. Press <Enter> to load the file.

Start O.C. Profile

Allows you to run the utility to save and load CMOS. Press <Enter> to run the utility.

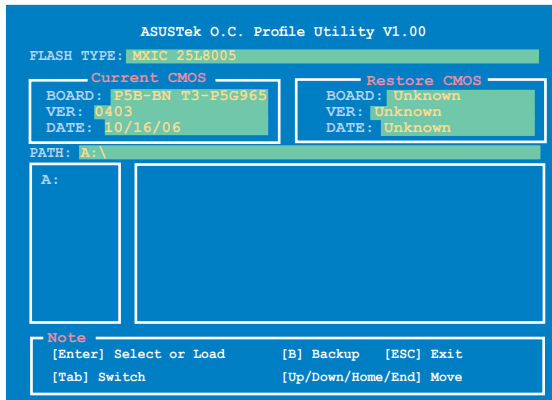

- This function can support devices such as USB flash disk or floppy disk with FAT 32/16 format only.
- DO NOT shut down or reset the system while updating the BIOS to prevent the system boot failure!

5.8 Exit menu

The Exit menu items allow you to load the optimal or failsafe default values for the BIOS items, and save or discard your changes to the BIOS items.



Pressing <Esc> does not immediately exit this menu. Select one of the options from this menu or <F10> from the legend bar to exit.

Exit & Save Changes

Once you are finished making your selections, choose this option from the Exit menu to ensure the values you selected are saved to the CMOS RAM. An onboard backup battery sustains the CMOS RAM so it stays on even when the PC is turned off. When you select this option, a confirmation window appears. Select **OK** to save changes and exit.



If you attempt to exit the Setup program without saving your changes, the program prompts you with a message asking if you want to save your changes before exiting. Press <Enter> to save the changes while exiting.

Exit & Discard Changes

Select this option only if you do not want to save the changes that you made to the Setup program. If you made changes to fields other than System Date, System Time, and Password, the BIOS asks for a confirmation before exiting.

Discard Changes

This option allows you to discard the selections you made and restore the previously saved values. After selecting this option, a confirmation appears. Select **OK** to discard any changes and load the previously saved values.

Load Setup Defaults

This option allows you to load the default values for each of the parameters on the Setup menus. When you select this option or if you press <F5>, a confirmation window appears. Select **OK** to load default values. Select **Exit & Save Changes** or make other changes before saving the values to the non-volatile RAM.